



Deutscher
Nachhaltigkeitspreis 2020

SIEGER
Großunternehmen

deutscher
nachhaltigkeitspreis



Perfektan duo.

Fischer AKKU tangencijalna
mašina za zavijanje FSS 18v i
fischer vijak za beton FBS.



SaMontec instalacioni sistemi



		Strana
Obujmice		224
FLS sistem montažnih šina za laka opterećenja		236
FUS sistem montažnih šina		240
Montaža ventilacije		258
Pribor za montažu		261
Pričvršćivanje klima uređaja		287
Pričvršćivanje sanitarija		291

FGRS Plus - Obujmice jednodielne

Tip	Br.Art.	GTIN (EAN-Code)	Pakovanje [Komada]	Veliko pakovanje [Komada]		Nazivna veličina [Col]	Odgovarajuće za cevi [mm]	Priključni navoj	Širina x debljina lima [mm]
-----	---------	-----------------	-----------------------	---------------------------------	--	------------------------------	---------------------------------	------------------	-----------------------------------



FGRS Plus

FGRS Plus 12 - 14	079400	4006209794005	100	100		1/4"	12 - 14	M 8	20 x 1,25
FGRS Plus 15 - 19	079401	4006209794012	100	100		3/8"	15 - 19	M 8	20 x 1,25
FGRS Plus 20 - 24	079402	4006209794029	100	100		1/2"	20 - 24	M 8	20 x 1,25
FGRS Plus 25 - 30	079403	4006209794036	100	100		3/4"	25 - 30	M 8	20 x 1,25
FGRS Plus 32 - 37	079404	4006209794043	100	100		1"	32 - 37	M 8	20 x 1,25
FGRS Plus 40 - 44	079405	4006209794050	50	50		1 1/4"	40 - 44	M 8	20 x 1,5
FGRS Plus 45 - 50	079406	4006209794067	50	50		1 1/2"	45 - 50	M 8	20 x 1,5
FGRS Plus 50 - 55	079407	4006209794074	50	50		-	50 - 55	M 8	20 x 1,5
FGRS Plus 56 - 63	079408	4006209794081	50	50		2"	56 - 63	M 8	20 x 1,5

FGRS Plus M8/M10 - Obujmice jednodielne

Tip	Br.Art.	GTIN (EAN-Code)	Pakovanje [Komada]	Veliko pakovanje [Komada]		Nazivna veličina [Col]	Odgovara- juće za cevi [mm]	Priključni navoj	Širina x debljina lima [mm]
-----	---------	-----------------	-----------------------	---------------------------------	--	------------------------------	-----------------------------------	------------------	-----------------------------------



FGRS Plus M8/M10

FGRS Plus 12 - 14 M8/M10	079430	4006209794302	100	100		1/4"	12 - 14	M 8 / M 10	20 x 1,25
FGRS Plus 15 - 19 M8/M10	079431	4006209794319	100	100		3/8"	15 - 19	M 8 / M 10	20 x 1,25
FGRS Plus 20 - 24 M8/M10	079432	4006209794326	100	100		1/2"	20 - 24	M 8 / M 10	20 x 1,25
FGRS Plus 25 - 30 M8/M10	079433	4006209794333	100	100		3/4"	25 - 30	M 8 / M 10	20 x 1,25
FGRS Plus 32 - 37 M8/M10	079434	4006209794340	100	100		1"	32 - 37	M 8 / M 10	20 x 1,25
FGRS Plus 40 - 44 M8/M10	079435	4006209794357	50	50		1 1/4"	40 - 44	M 8 / M 10	20 x 1,5
FGRS Plus 45 - 50 M8/M10	079436	4006209794364	50	50		1 1/2"	45 - 50	M 8 / M 10	20 x 1,5
FGRS Plus 50 - 55 M8/M10	079437	4006209794371	50	50		-	50 - 55	M 8 / M 10	20 x 1,5
FGRS Plus 56 - 63 M8/M10	079438	4006209794388	50	50		2"	56 - 63	M 8 / M 10	20 x 1,5

FGRS - Obujmice jednodielne

Tip	Br.Art.	GTIN (EAN-Code)	Pakovanje [Komada]	Veliko pakovanje [Komada]		Nazivna veličina [Col]	Odgovarajuće za cevi [mm]	Priključni navoj	Širina x debljina lima [mm]
-----	---------	-----------------	-----------------------	---------------------------------	--	------------------------------	---------------------------------	------------------	-----------------------------------



FGRS

FGRS 8 - 11	537212	4048962253788	100	100		-	8 - 11	M 8	20 x 1,25
FGRS 12 - 14	079420	4006209794203	100	100		1/4"	12 - 14	M 8	20 x 1,25
FGRS 15 - 19	079421	4006209794210	100	100		3/8"	15 - 19	M 8	20 x 1,25
FGRS 20 - 24	079422	4006209794227	100	100		1/2"	20 - 24	M 8	20 x 1,25
FGRS 25 - 30	079423	4006209794234	100	100		3/4"	25 - 30	M 8	20 x 1,25
FGRS 32 - 37	079424	4006209794241	100	100		1"	32 - 37	M 8	20 x 1,25
FGRS 40 - 44	079425	4006209794258	50	50		1 1/4"	40 - 44	M 8	20 x 1,5
FGRS 45 - 50	079426	4006209794265	50	50		1 1/2"	45 - 50	M 8	20 x 1,5

FGRS - Obujmice jednodielne									
Tip	Br.Art.	GTIN (EAN-Code)	Pakovanje [Komada]	Veliko pakovanje [Komada]		Nazivna veličina [Col]	Odgovarajuće za cevi [mm]	Priključni navoj	Širina x debljina lima [mm]
FGRS 50 - 55	079427	4006209794272	50	50		-	50 - 55	M 8	20 x 1,5
FGRS 56 - 63	079428	4006209794289	50	50		2"	56 - 63	M 8	20 x 1,5

FGRS M8/M10 - obujmice jednodielne									
Tip	Br.Art.	GTIN (EAN-Code)	Pakovanje [Komada]	Veliko pakovanje [Komada]		Nazivna veličina [Col]	Odgovarajuće za cevi [mm]	Priključni navoj	Širina x debljina lima [mm]



FGRS M8/M10

FGRS 12-14 M8/M10	512645	4048962117714	100	100		1/4"	12 - 14	M 8 / M 10	20 x 1,25
FGRS 15-19 M8/M10	512646	4048962117721	100	100		3/8"	15 - 19	M 8 / M 10	20 x 1,25
FGRS 20-24 M8/M10	512647	4048962117738	100	100		1/2"	20 - 24	M 8 / M 10	20 x 1,25
FGRS 25-30 M8/M10	512648	4048962117745	100	100		3/4"	25 - 30	M 8 / M 10	20 x 1,25
FGRS 32-37 M8/M10	512649	4048962117752	100	100		1"	32 - 37	M 8 / M 10	20 x 1,25
FGRS 40-44 M8/M10	512650	4048962117769	50	50		1 1/4"	40 - 44	M 8 / M 10	20 x 1,25
FGRS 45-50 M8/M10	512651	4048962117776	50	50		1 1/2"	45 - 50	M 8 / M 10	20 x 1,25
FGRS 56-63 M8/M10	512652	4048962117783	50	50		2"	56 - 63	M 8 / M 10	20 x 1,25

FKS Plus - obujmice jednodielne za PVC cevi									
Tip	Br.Art.	GTIN (EAN-Code)	Pakovanje [Komada]	Veliko pakovanje [Komada]		Nazivna veličina [Col]	Odgovarajuće za cevi [mm]	Priključni navoj	Širina x debljina lima [mm]



FKS Plus

FKS Plus 15 - 19	079470	4006209794708	100	100		3/8"	15 - 19	M 8	20 x 1,25
FKS Plus 20 - 24	079471	4006209794715	100	100		1/2"	20 - 24	M 8	20 x 1,25
FKS Plus 25 - 30	079472	4006209794722	100	100		3/4"	25 - 30	M 8	20 x 1,25
FKS Plus 32 - 37	079473	4006209794739	100	100		1"	32 - 37	M 8	20 x 1,25
FKS Plus 40 - 44	079474	4006209794746	50	50		1 1/4"	40 - 44	M 8	20 x 1,5
FKS Plus 45 - 50	079475	4006209794753	50	50		1 1/2"	45 - 50	M 8	20 x 1,5
FKS Plus 50 - 55	079476	4006209794760	50	50		-	50 - 55	M 8	20 x 1,5
FKS Plus 56 - 63	079477	4006209794777	50	50		2"	56 - 63	M 8	20 x 1,5

FRS Plus - objumice

Tip	Br.Art.	GTIN (EAN-Code)	Pakovanje [Komada]	Veliko pakovanje [Komada]		Nazivna veličina [Col]	Odgovara- juće za cevi [mm]	Priključni navoj	Širina x debl- jina lima [mm]
									
FRS Plus									
FRS Plus 12 - 15	079440	4006209794401	100	100		1/4"	12 - 15	M 8 / M 10	20 x 1,25
FRS Plus 15 - 19	079441	4006209794418	100	100		3/8"	15 - 19	M 8 / M 10	20 x 1,25
FRS Plus 20 - 24	079442	4006209794425	100	100		1/2"	20 - 24	M 8 / M 10	20 x 1,25
FRS Plus 25 - 30	079443	4006209794432	100	100		3/4"	25 - 30	M 8 / M 10	20 x 1,25
FRS Plus 32 - 37	079444	4006209794449	100	100		1"	32 - 37	M 8 / M 10	20 x 1,25
FRS Plus 40 - 45	079445	4006209794456	50	50		1 1/4"	40 - 45	M 8 / M 10	20 x 1,5
FRS Plus 48 - 54	079446	4006209794463	50	50		1 1/2"	48 - 54	M 8 / M 10	20 x 1,5
FRS Plus 55 - 61	079447	4006209794470	50	50		2"	55 - 61	M 8 / M 10	20 x 1,5
FRS Plus 63 - 67	079449	4006209794494	25	25		-	63 - 67	M 8 / M 10	20 x 1,5
FRS Plus 68 - 73	079450	4006209794500	25	25		-	68 - 73	M 8 / M 10	20 x 2,0
FRS Plus 72 - 80	079451	4006209794517	25	25		2 1/2"	72 - 80	M 8 / M 10	20 x 2,0
FRS Plus 80 - 86	079452	4006209794524	25	25		-	80 - 86	M 8 / M 10	20 x 2,0
FRS Plus 87 - 92	079453	4006209794531	25	25		3"	87 - 92	M 8 / M 10	20 x 2,0
FRS Plus 95 - 103	079454	4006209794548	25	25		-	95 - 103	M 8 / M 10	20 x 2,0
FRS Plus 108 - 116	079455	4006209794555	20	20		4"	108 - 116	M 8 / M 10	20 x 2,0

FRS - L - objumice za laka opterećenja

Tip	Br.Art.	GTIN (EAN-Code)	Pakovanje [Komada]	Veliko pakovanje [Komada]		Nazivna veličina [Col]	Odgovara- juće za cevi [mm]	Priključni navoj	Širina x debl- jina lima [mm]
									
FRS-L Universal									
FRS-L 8 - 11 Universal	539443	4048962269550	25	325		-	8 - 11	M 8 / M 10	18 x 1,0
FRS-L 12 - 15 Universal	539444	4048962269567	25	300		1/4"	12 - 15	M 8 / M 10	18 x 1,0
FRS-L 16 - 19 Universal	539445	4048962269574	25	275		3/8"	16 - 19	M 8 / M 10	18 x 1,0
FRS-L 20 - 24 Universal	539446	4048962269581	25	275		1/2"	20 - 24	M 8 / M 10	18 x 1,0
FRS-L 25 - 30 Universal	539447	4048962269598	25	275		3/4"	25 - 30	M 8 / M 10	18 x 1,0
FRS-L 31 - 37 Universal	539448	4048962269604	25	250		1"	31 - 37	M 8 / M 10	18 x 1,0
FRS-L 38 - 45 Universal	539449	4048962269611	25	200		1 1/4"	38 - 45	M 8 / M 10	18 x 1,2
FRS-L 46 - 52 Universal	539450	4048962269628	25	175		1 1/2"	46 - 52	M 8 / M 10	18 x 1,2
FRS-L 53 - 59 Universal	539451	4048962269635	25	175		-	53 - 59	M 8 / M 10	18 x 1,2
FRS-L 60 - 66 Universal	539452	4048962269642	10	160		2"	60 - 66	M 8 / M 10	18 x 1,2
FRS-L 67 - 75 Universal	539453	4048962269659	10	90		-	67 - 75	M 8 / M 10	20 x 1,8
FRS-L 76 - 84 Universal	539454	4048962269666	10	90		2 1/2"	76 - 84	M 8 / M 10	20 x 1,8
FRS-L 85 - 93 Universal	539455	4048962269673	10	80		3"	85 - 93	M 8 / M 10	20 x 1,8
FRS-L 94 - 100 Universal	539456	4048962269680	10	70		-	94 - 100	M 8 / M 10	20 x 1,8
FRS-L 101 - 110 Universal	539457	4048962269697	10	60		-	101 - 110	M 8 / M 10	20 x 1,8
FRS-L 111 - 119 Universal	539459	4048962269703	10	50		4"	111 - 119	M 8 / M 10	20 x 1,8
FRS-L 120 - 129 Universal	544905	4048962317824	5	40		-	120 - 129	M 8 / M 10	25 x 2,0
FRS-L 130 - 137 Universal	544906	4048962317831	5	35		-	130 - 137	M 8 / M 10	25 x 2,0
FRS-L 138 - 145 Universal	544907	4048962317848	5	35		5"	138 - 145	M 8 / M 10	25 x 2,0
FRS-L 146 - 155 Universal	544908	4048962317855	5	35		-	146 - 155	M 8 / M 10	25 x 2,0
FRS-L 156 - 163 Universal	544909	4048962317862	5	30		-	156 - 163	M 8 / M 10	25 x 2,0
FRS-L 164 - 172 Universal	544910	4048962317879	5	25		6"	164 - 172	M 8 / M 10	25 x 2,0

FRS Triple - obujmice sa trostrukim navojem

Tip	Br.Art.	GTIN (EAN-Code)	Pakovanje [Komada]	Veliko pakovanje [Komada]		Nazivna veličina [Col]	Odgovara- juće za cevi [mm]	Priključni navoj	Širina x debljina [mm]
-----	---------	-----------------	-----------------------	---------------------------------	--	------------------------------	-----------------------------------	------------------	------------------------------



FRS Triple - obujmice sa trostrukim navojem

FRS Triple 15 - 19	500698	4048962002003	100	100		3/8"	15 - 19	M 8 / M 10 / 1/2"	20 x 1,5
FRS Triple 21 - 23	500699	4048962002010	100	100		1/2"	21 - 23	M 8 / M 10 / 1/2"	20 x 1,5
FRS Triple 26 - 28	500700	4048962002027	100	100		3/4"	26 - 28	M 8 / M 10 / 1/2"	20 x 1,5
FRS Triple 32 - 35	500701	4048962002034	100	100		1"	32 - 35	M 8 / M 10 / 1/2"	20 x 1,5
FRS Triple 40 - 43	500702	4048962002041	50	50		1 1/4"	40 - 43	M 8 / M 10 / 1/2"	20 x 1,5
FRS Triple 48 - 56	500703	4048962002058	50	50		1 1/2"	48 - 56	M 8 / M 10 / 1/2"	20 x 1,5
FRS Triple 57 - 62	500704	4048962002065	50	50		2"	57 - 63	M 8 / M 10 / 1/2"	20 x 1,5
FRS Triple 63 - 70	500705	4048962002072	25	25		-	63 - 70	M 8 / M 10 / 1/2"	20 x 1,5
FRS Triple 74 - 80	500706	4048962002089	25	25		2 1/2"	74 - 80	M 8 / M 10 / 1/2"	20 x 1,5
FRS Triple 83 - 91	500707	4048962002096	25	25		3"	83 - 91	M 8 / M 10 / 1/2"	20 x 1,5
FRS Triple 100 - 105	500708	4048962002102	10	10		-	100 - 105	M 8 / M 10 / 1/2"	23 x 2,0
FRS Triple 108 - 114	500709	4048962002119	10	10		4"	108 - 114	M 8 / M 10 / 1/2"	23 x 2,0
FRS Triple 115 - 125	500710	4048962002126	10	10		-	115 - 125	M 8 / M 10 / 1/2"	23 x 2,0
FRS Triple 127 - 135	500711	4048962002133	10	10		-	127 - 135	M 8 / M 10 / 1/2"	23 x 2,0
FRS Triple 135 - 140	500712	4048962002140	10	10		5"	135 - 140	M 8 / M 10 / 1/2"	23 x 2,0
FRS Triple 159 - 169	500713	4048962002157	10	10		6"	159 - 169	M 8 / M 10 / 1/2"	23 x 2,0

FRS M8/M10 - obujmice

Tip	Br.Art.	GTIN (EAN-Code)	Pakovanje [Komada]	Veliko pakovanje [Komada]		Nazivna veličina [Col]	Odgovara- juće za cevi [mm]	Priključni navoj	Širina x debljina [mm]
-----	---------	-----------------	-----------------------	---------------------------------	--	------------------------------	-----------------------------------	------------------	------------------------------



FRS M8/M10

FRS 12 - 15 M8/M10	510969	4048962104660	100	100		1/4"	12 - 15	M 8 / M 10	20 x 1,25
FRS 15 - 19 M8/M10	042535	4006209425350	100	100		3/8"	15 - 19	M 8 / M 10	20 x 1,25
FRS 20 - 24 M8/M10	042536	4006209425367	100	100		1/2"	20 - 24	M 8 / M 10	20 x 1,25
FRS 25 - 30 M8/M10	042537	4006209425374	100	100		3/4"	25 - 30	M 8 / M 10	20 x 1,25
FRS 32 - 37 M8/M10	042538	4006209425381	100	100		1"	32 - 37	M 8 / M 10	20 x 1,25
FRS 40 - 45 M8/M10	042554	4006209425541	50	50		1 1/4"	40 - 45	M 8 / M 10	20 x 1,25
FRS 48 - 54 M8/M10	510970	4048962104677	50	50		1 1/2"	48 - 54	M 8 / M 10	20 x 1,25
FRS 55 - 61 M8/M10	042555	4006209425558	50	50		2"	55 - 61	M 8 / M 10	20 x 1,25
FRS 63 - 67 M8/M10	091488	4006209914885	50	50		-	63 - 67	M 8 / M 10	20 x 1,25
FRS 72 - 80 M8/M10	091489	4006209914892	25	25		2 1/2"	72 - 80	M 8 / M 10	20 x 2,0
FRS 87 - 92 M8/M10	091505	4006209915059	25	25		3"	87 - 92	M 8 / M 10	20 x 2,0
FRS 95 - 103 M8/M10	545649	4048962323498	25	25		-	95 - 103	M 8 / M 10	25 x 2,0
FRS 108 - 116 M8/M10	091506	4006209915066	20	20		4"	108 - 116	M 8 / M 10	25 x 2,0
FRS 121 - 128 M8/M10	079456	4006209794562	10	10		-	121 - 128	M 8 / M 10	25 x 2,5
FRS 133 - 141 M8/M10	079457	4006209794579	10	10		5"	133 - 141	M 8 / M 10	25 x 2,5
FRS 159 - 165 M8/M10	079458	4006209794586	8	8		-	159 - 165	M 8 / M 10	25 x 2,5
FRS 165 - 168 M8/M10	079459	4006209794593	8	8		6"	165 - 168	M 8 / M 10	25 x 2,5
FRS 200 - 206 M10	539660 *	4048962270860	15	15		-	200 - 206	M 10	25 x 2,5
FRS 210 - 219 M10	558335 *	4048962411539	15	15		8"	210 - 219	M 10	25 x 2,5

* ne poseduje kombinovanu priključnu maticu, priključna matica M10

FRSH - objumice za visoke temperature

Tip	Br.Art.	GTIN (EAN-Code)	Pakovanje [Komada]	Veliko pakovanje [Komada]		Nazivna veličina [Col]	Odgovara- juče za cevi [mm]	Priključni navoj	Širina x debljina [mm]
-----	---------	-----------------	-----------------------	---------------------------------	--	------------------------------	-----------------------------------	------------------	------------------------------



FRSH

FRSH 15 - 19	063490	4006209634905	100	100		3/8"	15 - 19	M 8	20 x 1,25
FRSH 20 - 24	063492	4006209634929	100	100		1/2"	20 - 24	M 8	20 x 1,25
FRSH 25 - 30	063494	4006209634943	100	100		3/4"	25 - 30	M 8	20 x 1,25
FRSH 32 - 37	063495	4006209634950	100	100		1"	32 - 37	M 8	20 x 1,25
FRSH 40 - 45	063498	4006209634981	50	50		1 1/4"	40 - 45	M 8	20 x 1,25
FRSH 48 - 53	063499	4006209634998	50	50		1 1/2"	48 - 53	M 8	20 x 1,25
FRSH 54 - 59	063500	4006209635001	50	50		-	54 - 59	M 8	20 x 1,25
FRSH 60 - 64	063502	4006209635025	50	50		2"	60 - 64	M 8	20 x 1,25
FRSH 68 - 73	063504	4006209635049	25	25		-	68 - 73	M 10	25 x 1,5
FRSH 72 - 78	063505	4006209635056	25	25		2 1/2"	72 - 78	M 10	25 x 1,5
FRSH 80 - 86	063511	4006209635117	25	25		-	80 - 86	M 10	25 x 1,5
FRSH 87 - 92	063513	4006209635131	25	25		3"	87 - 92	M 10	25 x 1,5
FRSH 95 - 103	063518	4006209635186	25	25		-	95 - 103	M 10	25 x 1,5
FRSH 102 - 116	063520	4006209635209	20	20		4"	102 - 116	M 10	25 x 2,0
FRSH 133 - 141	063537	4006209635377	10	10		5"	133 - 141	M 8 / M 10	25 x 2,5
FRSH 159 - 168	091507	4006209915073	8	8		-	159 - 168	M 8 / M 10	25 x 2,5

FRSN - Triple - objumice sa trostrukim navojem

Tip	Br.Art.	GTIN (EAN-Code)	Pakovanje [Komada]	Veliko pakovanje [Komada]		Nazivna veličina [Col]	Odgovara- juče za cevi [mm]	Priključni navoj	Širina x debljina [mm]
-----	---------	-----------------	-----------------------	---------------------------------	--	------------------------------	-----------------------------------	------------------	------------------------------



FRSN triple

FRSN Triple 15 - 19	500714	4048962002164	100	100		3/8"	15 - 19	M 8 / M 10 / 1/2"	20 x 1,5
FRSN Triple 21 - 23	500715	4048962002171	100	100		1/2"	21 - 23	M 8 / M 10 / 1/2"	20 x 1,5
FRSN Triple 26 - 28	500716	4048962002188	100	100		3/4"	26 - 28	M 8 / M 10 / 1/2"	20 x 1,5
FRSN Triple 32 - 35	500717	4048962002195	100	100		1"	32 - 35	M 8 / M 10 / 1/2"	20 x 1,5
FRSN Triple 40 - 43	500718	4048962002201	50	50		1 1/4"	40 - 43	M 8 / M 10 / 1/2"	20 x 1,5
FRSN Triple 48 - 56	500719	4048962002218	50	50		1 1/2"	48 - 56	M 8 / M 10 / 1/2"	20 x 1,5
FRSN Triple 57 - 62	500720	4048962002225	50	50		2"	57 - 63	M 8 / M 10 / 1/2"	20 x 1,5
FRSN Triple 63 - 70	500721	4048962002232	50	50		-	63 - 70	M 8 / M 10 / 1/2"	20 x 1,5
FRSN Triple 74 - 80	500722	4048962002249	25	25		2 1/2"	74 - 80	M 8 / M 10 / 1/2"	20 x 1,5
FRSN Triple 83 - 91	500723	4048962002256	25	25		3"	83 - 91	M 8 / M 10 / 1/2"	20 x 1,5
FRSN Triple 100 - 105	500724	4048962002263	10	10		-	100 - 105	M 8 / M 10 / 1/2"	20 x 1,5
FRSN Triple 108 - 114	500725	4048962002270	10	10		4"	108 - 114	M 8 / M 10 / 1/2"	23 x 2,0

FRSN - objumice bez gume									
Tip	Br.Art.	GTIN (EAN-Code)	Pakovanje [Komada]	Veliko pakovanje [Komada]		Nazivna veličina [Col]	Odgovara- juće za cevi [mm]	Priključni navoj	Širina x debljina [mm]



FRSN

FRSN 15 - 19 M8/M10	049459	4006209494592	100	100		3/8"	15 - 19	M 8 / M 10	20 x 1,5
FRSN 21 - 23 M8/M10	049789	4006209497890	100	100		1/2"	21 - 23	M 8 / M 10	20 x 1,5
FRSN 25 - 28 M8/M10	049790	4006209497906	100	100		3/4"	25 - 28	M 8 / M 10	20 x 1,5
FRSN 32 - 36 M8/M10	049793	4006209497937	100	100		1"	32 - 36	M 8 / M 10	20 x 1,5
FRSN 38 - 43 M8/M10	049794	4006209497944	50	50		1 1/4"	38 - 43	M 8 / M 10	20 x 1,5
FRSN 44 - 49 M8/M10	049902	4006209499023	50	50		1 1/2"	44 - 49	M 8 / M 10	20 x 1,5
FRSN 57 - 61 M8/M10	049944	4006209499443	50	50		2"	57 - 61	M 8 / M 10	20 x 1,5
FRSN 63 - 70 M8/M10	049945	4006209499450	50	50		-	63 - 70	M 8 / M 10	20 x 1,5
FRSN 70 - 77 M8/M10	049947	4006209499474	25	25		2 1/2"	70 - 77	M 8 / M 10	20 x 1,5
FRSN 80 - 83 M8/M10	049948	4006209499481	25	25		-	80 - 83	M 8 / M 10	20 x 1,5
FRSN 83 - 91 M8/M10	049979	4006209499795	25	25		3"	83 - 91	M 8 / M 10	20 x 2,0
FRSN 100 - 106 M8/M10	050006	4006209500064	25	25		-	100 - 106	M 8 / M 10	20 x 2,0
FRSN 108 - 114 M8/M10	050008	4006209500088	25	25		4"	108 - 114	M 8 / M 10	20 x 2,0
FRSN 118 - 122 M8/M10	500744	4048962002393	25	25		-	118 - 122	M 8 / M 10	20 x 2,0
FRSN 123 - 128 M8/M10	050009	4006209500095	25	25		-	123 - 128	M 8 / M 10	25 x 2,5
FRSN 131 - 136 M8/M10	050010	4006209500101	25	25		-	131 - 136	M 8 / M 10	25 x 2,5
FRSN 137 - 146 M8/M10	050023	4006209500231	25	25		5"	137 - 146	M 8 / M 10	25 x 2,5
FRSN 146 - 156 M8/M10	500746	4048962002416	25	25		-	146 - 156	M 8 / M 10	25 x 2,5
FRSN 159 - 165 M10/M12	500747	4048962002423	25	25		-	159 - 165	M 10 / M 12	25 x 2,5
FRSN 166 - 175 M10/M12	500748 1)	4048962002430	20	20		-	166 - 175	M 10 / M 12	25 x 2,5
FRSN 200 - 206 M10/M12	500751 1)	4048962002461	10	10		-	200 - 206	M 10 / M 12	25 x 2,5
FRSN 210 - 219 M10/M12	500752 1)	4048962002478	10	10		8"	210 - 219	M 10 / M 12	25 x 2,5

1) Od Ø 166 mm polovine trake objumice su izbušene i povezane vijkom i maticom.

FRSM - objumice za masivne cevi sa colovnim priključkom

Tip	Br.Art.	GTIN (EAN-Code)	Pakovanje [Komada]	Veliko pakovanje [Komada]	Nazivna veličina [Col]	Odgovarajuće za cevi [mm]	Priključni navoj	Širina x debljina [mm]
-----	---------	-----------------	-----------------------	---------------------------------	------------------------------	---------------------------------	------------------	------------------------------



FRSM

FRSM 3/8"	535494	4048962240238	25	25	3/8"	14 - 20	1/2"	20 x 2,0
FRSM 1/2"	535497	4048962240269	25	25	1/2"	21 - 26	1/2"	20 x 2,0
FRSM 3/4"	535498	4048962240276	25	25	3/4"	26 - 30	1/2"	20 x 2,0
FRSM 1"	535499	4048962240283	25	25	1"	31 - 38	1/2"	20 x 2,0
FRSM 1 1/4"	535500	4048962240290	25	25	1 1/4"	40 - 47	1/2"	20 x 2,0
FRSM 1 1/2"	535501	4048962240306	25	25	1 1/2"	48 - 54	1/2"	20 x 2,0
FRSM 2"	535502	4048962240313	25	25	2"	60 - 66	1/2"	20 x 2,0
FRSM 2 1/2"	535503	4048962240320	10	10	2 1/2"	73 - 80	1/2"	25 x 2,5
FRSM 3"	535504	4048962240337	10	10	3"	87 - 94	1/2"	25 x 2,5
FRSM 110 mm	535505	4048962240344	10	10	-	105 - 112	1/2"	25 x 2,5
FRSM 4"	535506	4048962240351	10	10	4"	112 - 118	1/2"	25 x 2,5
FRSM 133 mm	535507	4048962240368	10	10	-	132 - 137	1/2"	25 x 2,5
FRSM 5"	535508	4048962240375	10	10	5"	137 - 142	1/2"	25 x 2,5
FRSM 160 mm	535509	4048962240382	8	8	-	159 - 164	1/2"	25 x 2,5
FRSM 6"	535511	4048962240399	8	8	6"	164 - 169	1/2"	25 x 2,5

FRSM - objumice za masivne cevi sa metričkim priključkom

Tip	Br.Art.	GTIN (EAN-Code)	Pakovanje [Komada]	Veliko pakovanje [Komada]	Nazivna veličina [Col]	Odgovara- juće za cevi [mm]	Priključni navoj	Širina x debljina [mm]
-----	---------	-----------------	-----------------------	---------------------------------	------------------------------	-----------------------------------	------------------	------------------------------



FRSM M10/M12/M16

FRSM 1/2" M10/M12	504589	4048962063677	50	50	1/2"	19 - 23	M 10 / M 12	25 x 2,5
FRSM 3/4" M10/M12	504590	4048962063684	50	50	3/4"	24 - 29	M 10 / M 12	25 x 2,5
FRSM 1" M10/M12	504591	4048962063691	50	50	1"	33 - 36	M 10 / M 12	25 x 2,5
FRSM 1 1/4" M10/M12	504592	4048962063707	20	20	1 1/4"	40 - 45	M 10 / M 12	25 x 2,5
FRSM 1 1/2" M10/M12	093700	4006209937006	20	20	1 1/2"	47 - 52	M 10 / M 12	25 x 2,5
FRSM 53 - 58 M10/M12	093701	4006209937013	20	20	-	53 - 58	M 10 / M 12	25 x 2,5
FRSM 2" M10/M12	093702	4006209937020	20	20	2"	60 - 65	M 10 / M 12	25 x 2,5
FRSM 2 1/2" M10/M12	093703	4006209937037	20	20	2 1/2"	73 - 78	M 10 / M 12	30 x 3,0
FRSM 79 - 85 M10/M12	504593	4048962063714	20	20	-	79 - 85	M 10 / M 12	30 x 3,0
FRSM 3" M10/M12	093704	4006209937044	20	20	3"	88 - 93	M 10 / M 12	30 x 3,0
FRSM 102 M10/M12	093705	4006209937051	20	20	-	100 - 106	M 10 / M 12	30 x 3,0
FRSM 4" M10/M12	093707	4006209937075	20	20	4"	108 - 116	M 10 / M 12	30 x 3,0
FRSM 124 - 129 M10/M12	093709 1)	4006209937099	20	20	-	124 - 129	M 10 / M 12	30 x 3,0
FRSM 131 - 137 M10/M12	093710 1)	4006209937105	20	20	-	131 - 137	M 10 / M 12	30 x 3,0
FRSM 138 - 145 M10/M12	093711 1)	4006209937112	20	20	5"	138 - 145	M 10 / M 12	30 x 3,0
FRSM 156 - 162 M10/M12	093712 1)	4006209937129	20	20	-	156 - 162	M 10 / M 12	30 x 3,0
FRSM 165 - 171 M10/M12	093713 1)	4006209937136	20	20	6"	165 - 171	M 10 / M 12	30 x 3,0
FRSM 188 - 194 M10/M12	093714 1)	4006209937143	10	10	7"	188 - 194	M 10 / M 12	30 x 3,0
FRSM 196 - 203 M10/M12	093715 1)	4006209937150	10	10	-	196 - 203	M 10 / M 12	30 x 3,0
FRSM 212 M12/M16	505453 1)	4048962069792	10	10	-	205 - 214	M 12 / M 16	40 x 4,0
FRSM 8" M12/M16	505454 1)	4048962069808	10	10	8"	219 - 225	M 12 / M 16	40 x 4,0
FRSM 250 M12/M16	505455 1)	4048962069815	10	10	-	244 - 250	M 12 / M 16	40 x 4,0
FRSM 10" M12/M16	505456 1)	4048962069822	10	10	10"	267 - 273	M 12 / M 16	40 x 4,0
FRSM 277-283 M12/M16	558304 1)		10	10	-	277 - 283	M 12 / M 16	40 x 4,0
FRSM 300 M12/M16	505457 1)	4048962069839	10	10	-	297 - 304	M 12 / M 16	40 x 4,0
FRSM 305-316 M12/M16	552858 1)		10	10	-	305 - 316	M 12 / M 16	40 x 4,0
FRSM 12" M12/M16	505458 1)	4048962069846	10	10	12"	320 - 328	M 12 / M 16	40 x 4,0
FRSM 348 - 356 M16	504594 1)	4048962063721	1	1	-	348 - 356	M 16	50 x 5,0
FRSM 364 - 372 M16	504595 1)	4048962063738	1	1	-	364 - 372	M 16	50 x 5,0
FRSM 400 - 409 M16	504596 1)	4048962063745	1	1	-	400 - 409	M 16	50 x 5,0
FRSM 454 - 462 M16	504597 1)	4048962063752	1	1	-	454 - 462	M 16	50 x 5,0
FRSM 500 - 508 M16	504598 1)	4048962063769	1	1	-	500 - 508	M 16	50 x 5,0

1) Od Ø 124 mm polovine trake objumice su izbušene i povezane vijkom i maticom.

FRS K - obujmice za rashladne instalacije

Tip	Br.Art.	GTIN (EAN-Code)	Pakovanje [Komada]	Veliko pakovanje [Komada]	Nazivna veličina [Col]	Priključni navoj	Širina B [mm]	Visina H [mm]
-----	---------	-----------------	-----------------------	---------------------------------	------------------------------	------------------	------------------	------------------



FRS K

FRS K 12/13	506486	4048962074796	1	15	-	M 8 / M 10	77	59
FRS K 15/13	506487	4048962074802	1	15	1/4"	M 8 / M 10	85	64
FRS K 17-18/13	506488	4048962074819	1	15	3/8"	M 8 / M 10	86	64
FRS K 21-22/13	506489	4048962074826	1	10	1/2"	M 8 / M 10	90.5	69
FRS K 27-28/13	506490	4048962074833	1	10	3/4"	M 8 / M 10	98.5	78
FRS K 34-35/13	506491	4048962074840	1	10	1"	M 8 / M 10	105	83
FRS K 42/13	506492	4048962074857	1	14	1 1/4"	M 8 / M 10	115	96
FRS K 48-49/13	506493	4048962074864	1	14	1 1/2"	M 8 / M 10	118	102
FRS K 54/13	507699	4048962089448	1	14	-	M 8 / M 10	125	107
FRS K 60/13	506494	4048962074871	1	14	2"	M 8 / M 10	132	115
FRS K 12/19	506495	4048962074888	1	14	-	M 8 / M 10	90	71
FRS K 15/19	506496	4048962074895	1	14	1/4"	M 8 / M 10	90.5	74
FRS K 17-18/19	506497	4048962074901	1	10	3/8"	M 8 / M 10	99	77
FRS K 21-22/19	506498	4048962074918	1	10	1/2"	M 8 / M 10	99	77
FRS K 27-28/19	506499	4048962074925	1	10	3/4"	M 8 / M 10	106	90
FRS K 34-35/19	506500	4048962074932	1	10	1"	M 8 / M 10	115	97
FRS K 42/19	506501	4048962074949	1	14	1 1/4"	M 8 / M 10	125	109
FRS K 48-49/19	506502	4048962074956	1	14	1 1/2"	M 8 / M 10	132	116
FRS K 54/19	507700	4048962089455	1	14	-	M 8 / M 10	143	123
FRS K 60/19	506503	4048962074963	1	17	2"	M 8 / M 10	147	129
FRS K 64/19	506504	4048962074970	1	17	-	M 8 / M 10	149	134
FRS K 70/19	506505	4048962074987	1	17	-	M 8 / M 10	161	142
FRS K 76/19	506506	4048962074994	1	14	2 1/2"	M 8 / M 10	162.5	147
FRS K 89/19	506508	4048962075014	1	14	3"	M 8 / M 10	188	165
FRS K 102/19	506509	4048962075021	1	5	-	M 8 / M 10	199	180
FRS K 108/19	506510	4048962075038	1	5	-	M 8 / M 10	204	185
FRS K 114/19	506511	4048962075045	1	5	4"	M 8 / M 10	241	201
FRS K 133/19	507786	4048962089462	1	4	-	M 12 / M 16	270	221
FRS K 139/19	507787	4048962089479	1	4	5"	M 12 / M 16	270	227
FRS K 168/19	507788	4048962089486	1	4	6"	M 12 / M 16	281	256
FRS K 219/19	539477	4048962269819	1	3	8"	M 12 / M 16	346	290

KFT - obujmice za rashladne instalacije									
Tip	Br.Art.	GTIN (EAN-Code)	Pakovanje	Veliko pakovanje		Prečnik otvora za cev	Priključni navoj	Širina x debljina	Vijak za zaključavanje
			[Komada]	[Komada]		[mm]		[mm]	



KFT

KFT 9,5	505576 1)	4048962070569	1	10		9,5	M 8 / M 10 / 1/2"	40 x 30	M 6
KFT 12,7	505577	4048962070576	1	10		12,7	M 8 / M 10 / 1/2"	40 x 30	M 6
KFT 15,8	505578	4048962070583	1	10		15,8	M 8 / M 10 / 1/2"	40 x 30	M 6
KFT 17,2	505579 1)	4048962070590	1	10		17,2	M 8 / M 10 / 1/2"	40 x 30	M 6
KFT 18,0	505580	4048962070606	1	10		18,0	M 8 / M 10 / 1/2"	40 x 30	M 6
KFT 19,5	505581 1)	4048962070613	1	10		19,5	M 8 / M 10 / 1/2"	40 x 30	M 6
KFT 21,3	505582	4048962070620	1	10		21,3	M 8 / M 10 / 1/2"	40 x 30	M 6
KFT 22,0	505583	4048962070637	1	10		22,0	M 8 / M 10 / 1/2"	40 x 30	M 6
KFT 26,9	505584	4048962070644	1	10		26,9	M 8 / M 10 / 1/2"	40 x 30	M 6
KFT 28,0	505585	4048962070651	1	10		28,0	M 8 / M 10 / 1/2"	40 x 30	M 6
KFT 33,7	505587	4048962070675	1	10		33,7	M 8 / M 10 / 1/2"	40 x 30	M 6
KFT 35,0	505588	4048962070682	1	10		35,0	M 8 / M 10 / 1/2"	40 x 30	M 6
KFT 40,0	505589 1)	4048962070699	1	10		40,0	M 8 / M 10 / 1/2"	40 x 30	M 6
KFT 41,2	505591 1)	4048962070705	1	10		41,2	M 8 / M 10 / 1/2"	40 x 30	M 6
KFT 42,4	505592	4048962070712	1	10		42,4	M 8 / M 10 / 1/2"	40 x 30	M 6
KFT 44,5	505593 1)	4048962070729	1	10		44,5	M 8 / M 10 / 1/2"	40 x 30	M 6
KFT 48,3	505594	4048962070736	1	10		48,3	M 8 / M 10 / 1/2"	40 x 30	M 6
KFT 50,0	505595 1)	4048962070743	1	10		50,0	M 8 / M 10 / 1/2"	40 x 30	M 6
KFT 54,0	505596	4048962070750	1	10		54,0	M 8 / M 10 / 1/2"	40 x 30	M 6
KFT 57,0	505597	4048962070767	1	10		57,0	M 8 / M 10 / 1/2"	40 x 30	M 6
KFT 60,3	505598	4048962070774	1	10		60,3	M 8 / M 10 / 1/2"	50 x 30	M 6
KFT 64,0	505599	4048962070781	1	10		64,0	M 8 / M 10 / 1/2"	50 x 30	M 6
KFT 70,0	505901	4048962070804	1	10		70,0	M 8 / M 10 / 1/2"	50 x 30	M 8
KFT 74,0	505902 1)	4048962070811	1	10		74,0	M 8 / M 10 / 1/2"	50 x 30	M 8
KFT 76,1	505903	4048962070828	1	10		76,1	M 8 / M 10 / 1/2"	50 x 30	M 8
KFT 80,0	505904 1)	4048962070835	1	10		80,0	M 8 / M 10 / 1/2"	50 x 30	M 8
KFT 84,0	505905 1)	4048962070842	1	5		84,0	M 8 / M 10 / 1/2"	50 x 30	M 8
KFT 88,9	505906	4048962070859	1	5		88,0	M 8 / M 10 / 1/2"	50 x 30	M 8
KFT 92,1	505907 1)	4048962070866	1	5		92,1	M 8 / M 10 / 1/2"	50 x 30	M 8
KFT 101,0	505908 1)	4048962070873	1	5		101,0	M 8 / M 10 / 1/2"	60 x 40	M 8
KFT 104,0	505909 1)	4048962070880	1	5		104,0	M 8 / M 10 / 1/2"	60 x 40	M 8
KFT 108,0	505910	4048962070897	1	5		108,0	M 8 / M 10 / 1/2"	60 x 40	M 8
KFT 114,3	505911	4048962070903	1	5		114,3	M 8 / M 10 / 1/2"	60 x 40	M 8
KFT 129,0	505914 1)	4048962070927	1	5		129,0	M 8 / M 10 / 1/2"	60 x 40	M 8
KFT 133,0	505915	4048962070934	1	5		133,0	M 8 / M 10 / 1/2"	60 x 40	M 8
KFT 139,7	505916	4048962070941	1	5		139,7	M 8 / M 10 / 1/2"	60 x 40	M 8
KFT 154,0	505917 1)	4048962070958	1	4		154,0	M 12 / 1/2"	60 x 40	M 10
KFT 159,0	505918	4048962070965	1	4		159,0	M 12 / 1/2"	60 x 40	M 10
KFT 168,3	505919	4048962070972	1	4		168,3	M 12 / 1/2"	60 x 40	M 10
KFT 193,7	505920 1)	4048962070989	1	2		193,7	M 16 / 1/2"	100 x 60	M 10
KFT 204,0	505921 1)	4048962070996	1	1		204,0	M 16 / 1/2"	100 x 60	M 10
KFT 219,1	505922	4048962071009	1	1		219,1	M 16 / 1/2"	100 x 60	M 10
KFT 273	552859	4048962361902	1	1		273	M 20 / 3/4"	100 x 60	M 12
KFT 323,9	552860	4048962361919	1	1		323,9	M 20 / 3/4"	100 x 60	M 12

1) Rok isporuke na upit

ETR - U nosač / uzengija									
Tip	Br.Art.	GTIN (EAN-Code)	Pakovanje	Veliko pakovanje		Nazivna veličina	Navoj	Dužina L1	Širina B
			[Komada]	[Komada]		[Col]	[mm]	[mm]	[mm]



ETR

ETR 8 - 13	024415	4006209244159	10	100		1/4"	M 6	30	20
ETR 12 - 17	024416	4006209244166	10	100		3/8"	M 6	35	24
ETR 15 - 21	024417	4006209244173	10	100		1/2"	M 6	40	28
ETR 20 - 27	024418	4006209244180	10	50		3/4"	M 8	50	36
ETR 26 - 34	024419	4006209244197	10	50		1"	M 8	55	43
ETR 33 - 42	024420	4006209244203	10	50		1 1/4"	M 8	68	51
ETR 40 - 49	024421	4006209244210	10	50		1 1/2"	M 8	70	58
ETR 50 - 60	024422	4006209244227	10	50		2"	M 8	80	69
ETR 60 - 70	024423	4006209244234	10	100		-	M 10	100	82
ETR 66 - 76	024424	4006209244241	10	50		2 1/2"	M 10	110	88
ETR 70 - 82	024425	4006209244258	10	50		-	M 10	115	94
ETR 80 - 90	024426	4006209244265	10	50		3"	M 10	115	102
ETR 90 - 102	024427	4006209244272	5	50		3 1/2"	M 12	145	116
ETR 100 - 108	024428	4006209244289	5	50		-	M 12	150	122
ETR 102 - 114	024429	4006209244296	5	50		4"	M 12	156	128
ETR 121 - 127	024430	4006209244302	5	50		-	M 12	170	141
ETR 126 - 133	024431	4006209244319	5	50		-	M 12	180	147
ETR 131 - 140	024432	4006209244326	5	25		5"	M 14	185	156
ETR 143 - 153	024433	4006209244333	5	25		-	M 14	193	169
ETR 150 - 159	024434	4006209244340	5	25		-	M 14	200	175
ETR 168	024435	4006209244357	5	25		6"	M 14	210	184
ETR 193,7	024436	4006209244364	5	25		-	M 14	232	209
ETR 219	024437	4006209244371	5	25		8"	M 14	270	236

FRSL - obujmice za sprinkler instalacije sa VDS atestom									
Tip	Br.Art.	GTIN (EAN-Code)	Pakovanje	Veliko pakovanje		Nazivna veličina	Navoj	Širina x debljina	Visina H
			[Komada]	[Komada]		[Col]	[mm]	[mm]	[mm]



FRSL

FRSL 34 M8	538082	4048962260922	50	50		1"	M 8	10 x 1,8	67
FRSL 43 M8	538083	4048962260939	50	50		1 1/4"	M 8	10 x 1,8	67
FRSL 49 M8	538084	4048962260946	50	50		1 1/2"	M 8	10 x 1,8	72
FRSL 60 M8	538085	4048962260953	50	50		2"	M 8	10 x 1,8	81
FRSL 34	513302	4048962121773	50	50		1"	M 10	10 x 1,8	67
FRSL 43	513303	4048962121780	50	50		1 1/4"	M 10	10 x 1,8	67
FRSL 49	513304	4048962121797	50	50		1 1/2"	M 10	10 x 1,8	72
FRSL 60	513307	4048962121810	50	50		2"	M 10	10 x 1,8	81
FRSL 76	513308	4048962121827	25	25		2 1/2"	M 10	10 x 2,5	98
FRSL 90	513309	4048962121834	25	25		3"	M 10	10 x 2,5	113
FRSL 115	513310	4048962121841	25	25		4"	M 10	10 x 2,5	143
FRSL 140	513311	4048962121858	25	25		5"	M 12	13 x 2,5	157
FRSL 170	513312	4048962121865	25	25		6"	M 12	13 x 2,5	187

FRSP - objumice za sprinkler instalacije sa FM i UL atestom

Tip	Br.Art.	GTIN (EAN-Code)	Pakovanje [Komada]	Veliko pakovanje [Komada]	Navoj [mm]	Širina x debljina lima [mm]	Visina H [mm]
-----	---------	-----------------	-----------------------	---------------------------------	---------------	-----------------------------------	------------------



FRSP

FRSP 1/2"	516662	4048962139914	100	100	M 10 x 22,5	16 x 1,2	55
FRSP 3/4"	516663	4048962139921	100	100	M 10 x 22,5	16 x 1,2	62
FRSP 1"	516664	4048962139938	100	100	M 10 x 22,5	16 x 1,2	70
FRSP 1 1/4"	516665	4048962139945	100	100	M 10 x 22,5	16 x 1,2	78
FRSP 1 1/2"	516666	4048962139952	100	100	M 10 x 22,5	16 x 1,2	83
FRSP 2"	516667	4048962139969	100	100	M 10 x 22,5	16 x 1,2	93
FRSP 2 1/2"	516668	4048962139976	60	60	M 10 x 22,5	19 x 2,2	126
FRSP 3"	516669	4048962139983	60	60	M 10 x 22,5	19 x 2,2	147
FRSP 4"	516670	4048962139990	24	24	M 10 x 22,5	19 x 2,2	180
FRSP 5"	532356	4048962216011	24	24	M 12 x 26,8	19 x 2,5	210
FRSP 6"	516671	4048962140002	24	24	M 12 x 26,8	19 x 3,0	251
FRSP 8"	516672	4048962140019	12	12	M 12 x 26,8	19 x 3,0	301



SGS - objumice / šelne za creva

Tip	Br.Art.	GTIN (EAN-Code)	Pakovanje [Komada]	Veliko pakovanje [Komada]	Odgovarajuće za cevi [mm]	Širina x debljina [mm]
-----	---------	-----------------	-----------------------	---------------------------------	------------------------------	---------------------------

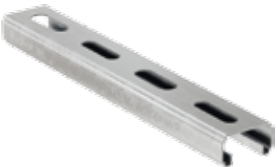

SGS

SGS 9 W2 8 - 12	045517	4006209455173	100	100	8 - 12	9,0 x 0,6
SGS 9 W2 10 - 16	045518	4006209455180	100	100	10 - 16	9,0 x 0,6
SGS 9 W2 12 - 20	045519	4006209455197	100	100	12 - 20	9,0 x 0,6
SGS 9 W2 16 - 27	045520	4006209455203	100	100	16 - 27	9,0 x 0,6
SGS 9 W2 20 - 32	045521	4006209455210	100	100	20 - 32	9,0 x 0,6
SGS 9 W2 25 - 40	045522	4006209455227	100	100	25 - 40	9,0 x 0,6
SGS 9 W2 32 - 50	045523	4006209455234	100	100	32 - 50	9,0 x 0,6
SGS 9 W2 40 - 60	045524	4006209455241	25	25	40 - 60	9,0 x 0,6
SGS 9 W2 50 - 70	045525	4006209455258	25	25	50 - 70	9,0 x 0,6
SGS 9 W2 60 - 80	045526	4006209455265	25	25	60 - 80	9,0 x 0,6
SGS 9 W2 70 - 90	045527	4006209455272	25	25	70 - 90	9,0 x 0,6
SGS 9 W2 80 -100	045528	4006209455289	25	25	80 - 100	9,0 x 0,6
SGS 9 W2 90 -110	045529	4006209455296	25	25	90 - 110	9,0 x 0,6
SGS 9 W2 100 -120	045530	4006209455302	25	25	100 - 120	9,0 x 0,6
SGS 9 W2 110 -130	045531	4006209455319	25	25	110 - 130	9,0 x 0,6
SGS 9 W2 120 -140	045532	4006209455326	25	25	120 - 140	9,0 x 0,6

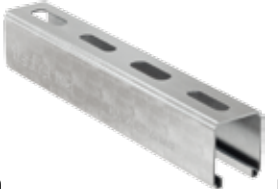
FLS - montažne šine						
Tip	Br.Art.	GTIN (EAN-Code)	Pakovanje [Komada]	Veliko pakovanje [Komada]		Dužina [mm]
						
						
						
FLS 17/1.0 - 2 m	538753	4048962265989	10	10		2000
FLS 17/1.0 - 3 m	538754	4048962265996	8	8		3000
FLS 30/1.0 - 2 m	538755	4048962266009	10	10		2000
FLS 30/1.0 - 3 m	538756	4048962266016	8	8		3000
FLS 37/1.2 - 2 m	538757	4048962266023	10	10		2000
FLS 37/1.2 - 3 m	538758	4048962266030	8	8		3000
FLS 37/1.2 - 6 m	538759	4048962266047	1	96		6000



FLS alat za sečenje profila						
Tip	Br.Art.	GTIN (EAN-Code)	Pakovanje [Komada]	Veliko pakovanje [Komada]		
						

FLS alat za sečenje profila

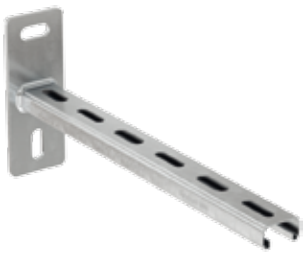
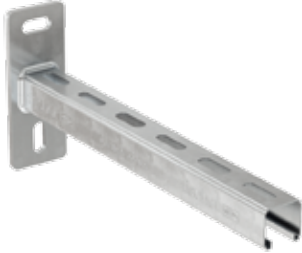
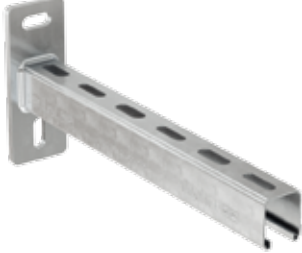
FLS alat za sečenje profila	543965	4048962310870	1	1		
-----------------------------	--------	---------------	---	---	--	--

ALK - konzole							
Tip	Br.Art.	GTIN (EAN-Code)	Pakovanje [Komada]	Veliko pakovanje [Komada]		Dužina [mm]	Profil
							
							
							

ALK 17-200	538738	4048962265835	10	10		200	17/1,0
ALK 17-300	538739	4048962265842	10	10		300	17/1,0
ALK 30-200	538740	4048962265859	10	10		200	30/1,0
ALK 30-300	538741	4048962265866	10	10		300	30/1,0
ALK 30-450	538742	4048962265873	10	10		450	30/1,0
ALK 37-300	538743	4048962265880	10	10		300	37/1,2
ALK 37-450	538744	4048962265897	10	10		450	37/1,2
ALK 37-600	538745	4048962265903	5	5		600	37/1,2

AK - kapa završna						
Tip	Br.Art.	GTIN (EAN-Code)	Pakovanje [Komada]	Veliko pakovanje [Komada]		Za Profil
 AK 17	538746	4048962265910	100	100		17/1.0
 AK 30	538747	4048962265927	100	100		30/1.0
 AK 37	538748	4048962265934	50	50		37/1.2

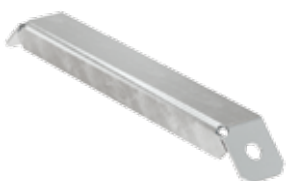
WS 31-45° - kosnik						
Tip	Br.Art.	GTIN (EAN-Code)	Pakovanje [Komada]	Veliko pakovanje [Komada]		Rupa-Ø [mm]
 WS 31-45°	538749	4048962265941	10	10		11

SV - spojnica šine						
Tip	Br.Art.	GTIN (EAN-Code)	Pakovanje [Komada]	Veliko pakovanje [Komada]		Rupa-Ø [mm]
 SV 31	538641	4048962265033	25	25		8.5

FSM Clix P - navrtka klizna						
Tip	Br.Art.	GTIN (EAN-Code)	Pakovanje [Komada]	Veliko pakovanje [Komada]		Navoj
 FSM Clix P	538643	4048962265040	50	50		M 6
FSM Clix P 8	538647	4048962265088	50	50		M 8
FSM Clix P 10	538649	4048962265101	50	50		M 10

FSM Clix M - navrtka klizna							
Tip	Br.Art.	GTIN (EAN-Code)	Pakovanje [Komada]	Veliko pakovanje [Komada]		Otvor ključa SW [mm]	Navoj



FSM Clix M

FSM Clix M 6	538650	4048962265125	50	50		10	M 6
FSM Clix M 8	538651	4048962265132	50	50		13	M 8
FSM Clix M 10	538652	4048962265149	50	50		17	M 10

FHS Clix - vijak sa T glavom								
Tip	Br.Art.	GTIN (EAN-Code)	Pakovanje [Komada]	Veliko pakovanje [Komada]		Otvor ključa SW [mm]	Dužina L1 [mm]	Navoj



FHS Clix

FHS CLIX 8 x 30	538653	4048962265156	100	100		13	40	M 8
FHS CLIX 8 x 40	538654	4048962265163	100	100		13	50	M 8
FHS CLIX 8 x 60	538655	4048962265170	100	100		13	70	M 8
FHS CLIX 8 x 80	538656	4048962265187	50	50		13	90	M 8
FHS CLIX 8 x 100	538657	4048962265194	50	50		13	110	M 8
FHS CLIX 8 x 140	545834	4048962324402	50	50		13	-	M 8
FHS CLIX 8 x 190	545835	4048962324426	50	50		13	-	M 8
FHS CLIX 10 x 30	538658	4048962265200	100	100		17	40	M 10
FHS CLIX 10 x 40	538659	4048962265217	100	100		17	50	M 10
FHS CLIX 10 x 60	538660	4048962265224	50	50		17	70	M 10
FHS CLIX 10 x 80	545836	4048962324433	50	50		17	-	M 10
FHS CLIX 10 x 100	538661	4048962265231	50	50		17	110	M 10

SF Clix 31 - stopa šine							
Tip	Br.Art.	GTIN (EAN-Code)	Pakovanje [Komada]	Veliko pakovanje [Komada]		Otvor ključa SW [mm]	Navoj

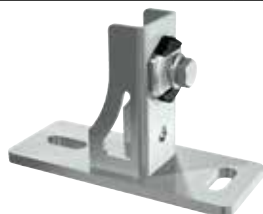

SF Clix 31

SF Clix 31	538665	4048962265262	10	10		13	M 8
------------	--------	---------------	----	----	--	----	-----

MW Clix 90 -ugaonik montažni							
Tip	Br.Art.	GTIN (EAN-Code)	Pakovanje [Komada]	Veliko pakovanje [Komada]		Otvor ključa SW [mm]	Navoj



MW Clix 90

MW Clix 90°	538666	4048962265279	10	10		13	M 8
-------------	--------	---------------	----	----	--	----	-----

MW / MWU -ugaonik montažni							
Tip	Br.Art.	GTIN (EAN-Code)	Pakovanje [Komada]	Veliko pakovanje [Komada]		Rupa-Ø [mm]	



MW 90°



MWU 90°

MW 90°	538668	4048962265293	50	50		8.5	
MWU 90°	538667	4048962265286	25	25		8.5	

HK 31 Držač šine							
Tip	Br.Art.	GTIN (EAN-Code)	Pakovanje [Komada]	Veliko pakovanje [Komada]		Rupa-Ø [mm]	



HK 31

HK 31 8,5	538663	4048962265248	50	50		8.5	
HK 31 10,5	538664	4048962265255	50	50		10,5	

TKR 31 - nosač šine							
Tip	Br.Art.	GTIN (EAN-Code)	Pakovanje [Komada]	Veliko pakovanje [Komada]		Otvor ključa SW [mm]	Navoj



TKR 31

TKR 31	538751	4048962265965	25	25		10	M 6
--------	--------	---------------	----	----	--	----	-----

Montažne šine FUS							
Tip	Br.Art.	GTIN (EAN-Code)	Pakovanje [Komada]	Veliko pakovanje [Komada]	Dužina [mm]	Debljina lima [mm]	



FUS 21/1,5 - 2 m	545117	4048962320596	1	50	2000	1,5
FUS 21/1,5 - 3 m	545118	4048962320602	1	50	3000	1,5
FUS 21/1,5 - 6 m	545119 1)	4048962320619	1	50	6000	1,5
FUS 21/2,0 - 2 m	040391	4006209403914	1	50	2000	2
FUS 21/2,0 - 3 m	097660	4006209976609	1	1	3000	2
FUS 21/2,5 - 2 m	092867	4006209928677	1	50	2000	2,5
FUS 21/2,5 - 3 m	077349	4006209773499	1	1	3000	2,5
FUS 21/2,5 - 6 m	077541	4006209775417	1	1	6000	2,5
FUS 41/1,5 - 2 m	545120	4048962320626	1	50	2000	1,5
FUS 41/1,5 - 3 m	545126	4048962320633	1	50	3000	1,5
FUS 41/1,5 - 6 m	545127	4048962320640	1	50	6000	1,5
FUS 41/2,0 - 2 m	040390	4006209403907	1	50	2000	2
FUS 41/2,0 - 3 m	097658	4006209976586	1	1	3000	2
FUS 41/2,0 - 6 m	097659	4006209976593	1	50	6000	2
FUS 41/2,5 - 2 m	092295	4006209922958	1	50	2000	2,5
FUS 41/2,5 - 3 m	077347	4006209773475	1	1	3000	2,5
FUS 41/2,5 - 6 m	077537	4006209775370	1	1	6000	2,5
FUS 62/2,5 - 6 m	504457	4048962063011	1	1	6000	2,5



FUS 21D/2,0 - 3 m	504458	4048962063028	1	1	3000	2
FUS 21D/2,0 - 6 m	535531	4048962240504	1	1	6000	2
FUS 41D/2,5 - 6 m	504459	4048962063035	1	25	6000	2,5
FUS 62D/2,5 - 6 m	504460	4048962063042	1	1	6000	2,5

1) upitati za rok isporuke

FUF OC i PFUF OC -spojnica šine							
Tip	Br.Art.	GTIN (EAN-Code)	Pakovanje [Komada]	Veliko pakovanje [Komada]	Dužina [mm]		

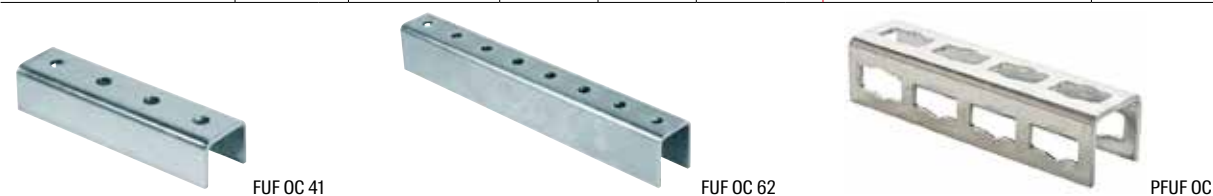

FUF OC 41	504517	4048962063264	20	20	200	
FUF OC 62	504518	4048962063271	10	10	400	
PFUF OC	533743	4048962225082	6	6	194	

FCA - konzole

Tip	Br.Art.	GTIN (EAN-Code)	Pakovanje [Komada]	Veliko pakovanje [Komada]	Br.	Dužina [mm]	Profil
-----	---------	-----------------	-----------------------	---------------------------------	-----	----------------	--------



FCA 21



FCA 41



FCA 62

FCA 21 - 200	537207	4048962253733	1	1		200	21/2,0
FCA 21 - 300	537208	4048962253740	1	1		300	21/2,0
FCA 21 - 450	537209	4048962253757	1	1		450	21/2,0
FCA 41 - 300	077359	4006209773598	1	1		300	41/2,5
FCA 41 - 450	077361	4006209773611	1	1		450	41/2,5
FCA 41 - 600	077363	4006209773635	1	1		600	41/2,5
FCA 41 - 750	077365	4006209773659	1	1		750	41/2,5
FCA 62 - 1000	504315	4048962062366	1	1		1000	62/2,5



FCA 21D



FCA 41 D

FCA 21D - 300	536978	4048962253016	1	1		300	21D/2,0
FCA 21D - 450	536979	4048962253023	1	1		450	21D/2,0
FCA 21D - 600	536980	4048962253030	1	1		600	21D/2,0
FCA 41D - 750	504317	4048962062373	1	1		750	41D/2,5
FCA 41D - 1000	504319	4048962062380	1	1		1000	41D/2,5



FCAM - konzole

Tip	Br.Art.	GTIN (EAN-Code)	Pakovanje [Komada]	Veliko pakovanje [Komada]	Br.	Dužina [mm]	Visina H [mm]
-----	---------	-----------------	-----------------------	---------------------------------	-----	----------------	------------------







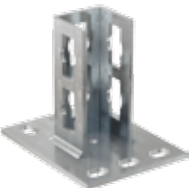

FCAM

FCAM 300	504477	4048962063127	1	1		300	246
FCAM 400	504479	4048962063134	1	1		400	270
FCAM 500	504480	4048962063141	1	1		500	284
FCAM 600	504482	4048962063158	1	1		600	319
FCAM 700	505460	4048962069860	1	1		700	343

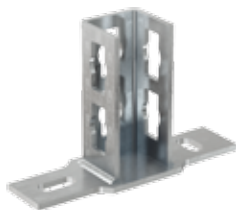
FEC - kapa završna						
Tip	Br.Art.	GTIN (EAN-Code)	Pakovanje [Komada]	Veliko pakovanje [Komada]		Za Profil
						
FEC 21 B	077357	4006209773574	100	100		41/21
						
FEC 41 B	077355	4006209773550	100	100		41/41
						
FEC 62 B	505551	4048962070460	100	100		41/62

PFCN - vijak za brzo spajanje						
Tip	Br.Art.	GTIN (EAN-Code)	Pakovanje [Komada]	Veliko pakovanje [Komada]		Navoj
						
PFCN 41	533739	4048962225044	50	50		M 10

PSF - Elementi i pribor za brzo spajanje FUS profila						
Tip	Br.Art.	GTIN (EAN-Code)	Pakovanje [Komada]	Veliko pakovanje [Komada]		Za Profil
						
PSF 41	533740	4048962225051	10	10		21D, 41, 62
						
PSF 82	533741	4048962225068	5	5		41 D
						
PSF 124	533742	4048962225075	5	5		62 D
						
PSFQ 41	535266	4048962239263	10	10		41

PUWS - Elementi i pribor za brzo spajanje FUS profila						
Tip	Br.Art.	GTIN (EAN-Code)	Pakovanje [Komada]	Veliko pakovanje [Komada]		
						
PUWS 2 x 2/135°	533731	4048962224979	10	10		
						
PUWS 2 x 2	533733	4048962224986	10	10		
						
PUWS 4 x 4	533734	4048962224993	8	8		

PWK - nosač univerzalni

Tip	Br.Art.	GTIN (EAN-Code)	Pakovanje [Komada]	Veliko pakovanje [Komada]		
-----	---------	-----------------	-----------------------	---------------------------------	--	--



PWK 200/200

PWK 200/200	533744	4048962225099	15	15		
-------------	--------	---------------	----	----	--	--

PVB - nosač šine univerzalni

Tip	Br.Art.	GTIN (EAN-Code)	Pakovanje [Komada]	Veliko pakovanje [Komada]		
-----	---------	-----------------	-----------------------	---------------------------------	--	--



PVB

PVB	534960	4048962236903	5	5		
-----	--------	---------------	---	---	--	--

PSAE kosnik

Tip	Br.Art.	GTIN (EAN-Code)	Pakovanje [Komada]	Veliko pakovanje [Komada]		Dužina [mm]
-----	---------	-----------------	-----------------------	---------------------------------	--	----------------





PSAE





PSAE 300 kosnik	535269	4048962239294	10	10		300
PSAE 500 kosnik	535270	4048962239300	10	10		500





PU podloška

PU 10,5 podloška	535271	4048962239317	50	50		-
PU 12,5 podloška	535272	4048962239324	50	50		-

PFFF montažni ugaoni element					
Tip	Br.Art.	GTIN (EAN-Code)	Pakovanje [Komada]	Veliko pakovanje [Komada]	
					
	PFFF 2L				
					
	PFFF 4L				
PFFF 2L	533745	4048962225105	20	20	
PFFF 4L	535268	4048962239287	25	25	

PFAF montažni ugaoni element					
Tip	Br.Art.	GTIN (EAN-Code)	Pakovanje [Komada]	Veliko pakovanje [Komada]	
					
	PFAF 2				
					
	PFAF 3				
					
	PFAF 4				
					
	PFAF 4/135°				
PFAF 2	533735	4048962225006	25	25	
PFAF 3	533736	4048962225013	25	25	
PFAF 4	535267	4048962239270	25	25	
PFAF 4/135°	533737	4048962225020	20	20	

PFUF element za spajanje profila					
Tip	Br.Art.	GTIN (EAN-Code)	Pakovanje [Komada]	Veliko pakovanje [Komada]	
					
	PFUF 41				
PFUF 41	533738	4048962225037	25	25	

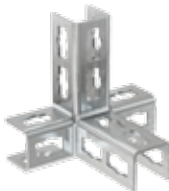
PFUF D element za spajanje profila					
Tip	Br.Art.	GTIN (EAN-Code)	Pakovanje [Komada]	Veliko pakovanje [Komada]	
					
	PFUF 3DR				
					
	PFUF 3DL				
					
	PFUF 4D				
PFUF 3DR	535274	4048962239348	10	10	
PFUF 3DL	535273	4048962239331	10	10	
PFUF 4D	535275	4048962239355	10	10	

FCN Clix P / FCN Clix M - navrtka klizna							
Tip	Br.Art.	GTIN (EAN-Code)	Pakovanje [Komada]	Veliko pakovanje [Komada]		Navoj	Debljina [mm]



FCN Clix P

FCN Clix P 6	504326	4048962062403	100	100		M 6	6
FCN Clix P 8	504327	4048962062410	100	100		M 8	6
FCN Clix P 10	504329	4048962062434	100	100		M 10	8
FCN Clix P 12	504331	4048962062458	100	100		M 12	9,5

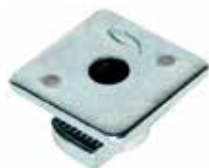

FCN Clix M

FCN Clix M 6	504344	4048962062472	100	100		M 6	6
FCN Clix M 8	504345	4048962062489	100	100		M 8	6
FCN Clix M 10	504346	4048962062496	100	100		M 10	8
FCN Clix M 12	504347	4048962062502	100	100		M 12	9,5

FHS Clix-S - vijak sa T glavom								
Tip	Br.Art.	GTIN (EAN-Code)	Pakovanje [Komada]	Veliko pakovanje [Komada]		Navoj [mm]	Dužina L1 [mm]	Dužina L2 [mm]



FHS Clix-S

FHS CLIX S 8 x 30	020914	4006209209141	50	50		M 8	36	30
FHS CLIX S 8 x 40	020915	4006209209158	50	50		M 8	46	40
FHS CLIX S 8 x 60	020916	4006209209165	50	50		M 8	66	60
FHS CLIX S 10 x 30	020917	4006209209172	50	50		M 10	37	30
FHS CLIX S 10 x 40	020918	4006209209189	50	50		M 10	47	40
FHS CLIX S 10 x 60	020919	4006209209196	50	50		M 10	67	60
FHS CLIX S 12 x 30	020969	4006209209691	50	50		M 12	38	30
FHS CLIX S 12 x 40	047316	4006209473160	50	50		M 12	48	40
FHS CLIX S 12 x 60	504320	4048962062397	50	50		M 12	68	60

FCSN - vijak sa T glavom

Tip	Br.Art.	GTIN (EAN-Code)	Pakovanje [Komada]	Veliko pakovanje [Komada]	Navoj [mm]	Dužina L1 [mm]	Dužina L2 [mm]
-----	---------	-----------------	-----------------------	---------------------------------	---------------	-------------------	-------------------



FCSN

FCSN M 8 x 30	092960	4006209929605	50	50	M 8	36	30
FCSN M 8 x 40	092961	4006209929612	50	50	M 8	46	40
FCSN M 8 x 50	093354	4006209933541	50	50	M 8	56	50
FCSN M 8 x 60	093355	4006209933558	50	50	M 8	66	60
FCSN M 10 x 30	093360	4006209933602	50	50	M 10	38	30
FCSN M 10 x 40	093361	4006209933619	50	50	M 10	48	40
FCSN M 10 x 50	093362	4006209933626	50	50	M 10	58	50
FCSN M 10 x 60	093363	4006209933633	50	50	M 10	68	60
FCSN M 12 x 30	093366	4006209933664	50	50	M 12	39	30
FCSN M 12 x 40	093367	4006209933671	50	50	M 12	49	40

FCN klizna navrtka

Tip	Br.Art.	GTIN (EAN-Code)	Pakovanje [Komada]	Veliko pakovanje [Komada]	Navoj	Debljina [mm]
-----	---------	-----------------	-----------------------	---------------------------------	-------	------------------



FCN

FCN 6	077405	4006209774052	100	100	M 6	6
FCN 8	077407	4006209774076	100	100	M 8	6
FCN 10	077409	4006209774090	100	100	M 10	8
FCN 12	077411	4006209774113	100	100	M 12	9



HK 41 - držač profila

Tip	Br.Art.	GTIN (EAN-Code)	Pakovanje [Komada]	Veliko pakovanje [Komada]	Rupa-Ø [mm]
-----	---------	-----------------	-----------------------	---------------------------------	----------------







HK

HK 41 8,5	547492	4048962336726	50	50	8,5
HK 41 10,5	547493	4048962336733	50	50	10,5
HK 41 12,5	547494	4048962336740	50	50	12,5

SF - stopa šine						
Tip	Br.Art.	GTIN (EAN-Code)	Pakovanje [Komada]	Veliko pakovanje [Komada]		Za Profil
						
SF						
						
SF L 82	504357	4048962062564	5	5		41 D
						
SF L 124	504358	4048962062571	5	5		62 D

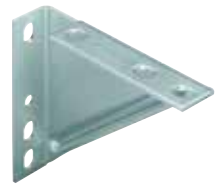
UWS - ugaonik univerzalni						
Tip	Br.Art.	GTIN (EAN-Code)	Pakovanje [Komada]	Veliko pakovanje [Komada]		
						
UWS	049479	4006209494790	10	10		

WK - nosač univerzalni						
Tip	Br.Art.	GTIN (EAN-Code)	Pakovanje [Komada]	Veliko pakovanje [Komada]		
						
WK 100/100	063559	4006209635599	5	5		
						
WK 200/200	079570	4006209795705	5	5		
						
WK 207/165	079571	4006209795712	6	6		

UHRS - nosač univerzalni						
Tip	Br.Art.	GTIN (EAN-Code)	Pakovanje [Komada]	Veliko pakovanje [Komada]		Mogućnost priključka
						
UHRS	063938	4006209639382	6	6		M8, M10, M12

FUH nosač zglobni						
Tip	Br.Art.	GTIN (EAN-Code)	Pakovanje [Komada]	Veliko pakovanje [Komada]		



FUH

FUH 13	543065	4048962302219	6	6		
--------	--------	---------------	---	---	--	--

VB - nosač šine univerzalni						
Tip	Br.Art.	GTIN (EAN-Code)	Pakovanje [Komada]	Veliko pakovanje [Komada]		Langrupa [mm]



VB

VB	004850	8001132048504	4	4		13 x 20
----	--------	---------------	---	---	--	---------

FSB - zatezni element						
Tip	Br.Art.	GTIN (EAN-Code)	Pakovanje [Komada]	Veliko pakovanje [Komada]		



FSB

FSB 45°	071269	8001132712696	20	20		
---------	--------	---------------	----	----	--	--





TKR - nosač šine							
Tip	Br.Art.	GTIN (EAN-Code)	Pakovanje [Komada]	Veliko pakovanje [Komada]		Navoj [mm]	Za Profil

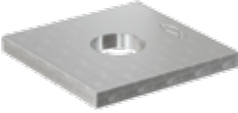

TKR

TKR 21 - 42	504363	4048962062625	20	20		M 8	21/41
TKR 82	504366	4048962062632	20	20		M 10	62, 41D
TKR 124	504367	4048962062649	10	10		M 10	62 D



FFF - ploče za spajanje





Tip	Br.Art.	GTIN (EAN-Code)	Pakovanje [Komada]	Veliko pakovanje [Komada]		
	FFF 1					
	FFF 3L					
	FFF 4					
FFF 1	547500	4048962336801	25	25		
FFF 3L	504498	4048962063189	25	25		
FFF 4	547501	4048962336818	25	25		
	FFF 4D					
	FFF 4T					
FFF 4D	504368	4048962062656	25	25		
FFF 4T	504500	4048962063202	25	25		

FAF elementi za ugaono spajanje

Tip	Br.Art.	GTIN (EAN-Code)	Pakovanje [Komada]	Veliko pakovanje [Komada]		
	FAF					
FAF 2	547502	4048962336825	25	25		
FAF 3	547503	4048962336832	25	25		
FAF 4	547504	4048962336849	25	25		
FAF 4/135°	547505	4048962336856	25	25		

FZF elementi za spajanje

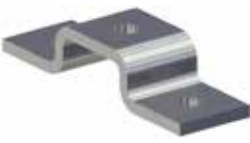
Tip	Br.Art.	GTIN (EAN-Code)	Pakovanje [Komada]	Veliko pakovanje [Komada]		
	FZF 21					
	FZF 41					
FZF 21	504375	4048962062670	25	25		
FZF 41	504515	4048962063240	25	25		

FUF elementi za spajanje					
Tip	Br.Art.	GTIN (EAN-Code)	Pakovanje [Komada]	Veliko pakovanje [Komada]	
					
					FUF 4Y
					
					FUF 180°L
					
					FUF 180°R
					
					FUF 8T
					
					FUF 21
					
					FUF 41
FUF 4Y	504378	4048962062700	20	20	
FUF 180°L	504379	4048962062717	20	20	
FUF 180°R	504383	4048962062724	20	20	
FUF 8T	504387	4048962062731	10	10	
FUF 21	504376	4048962062687	25	25	
FUF 41	504377	4048962062694	25	25	

Montažne šine FUS

Tip	Br.Art.	GTIN (EAN-Code)	Pakovanje [Komada]	Veliko pakovanje [Komada]	Dužina [mm]	Debljina lima [mm]
-----	---------	-----------------	-----------------------	---------------------------------	----------------	-----------------------



FUS 62



FUS 62 D

FUS 62/2,5 - 6 m	504457	4048962063011	1	1	6000	2,5
FUS 62D/2,5 - 6 m	504460	4048962063042	1	1	6000	2,5

FVS Povezivač poprečni

Tip	Br.Art.	GTIN (EAN-Code)	Pakovanje [Komada]	Veliko pakovanje [Komada]	Dužina [mm]	Debljina lima [mm]
-----	---------	-----------------	-----------------------	---------------------------------	----------------	-----------------------



Verbindungssattel FVS

FVS 3 II	543060	4048962302196	8	8		
FVS 4 II	543063	4048962302202	5	5		

FUF OC - spojnica šine

Tip	Br.Art.	GTIN (EAN-Code)	Pakovanje [Komada]	Veliko pakovanje [Komada]	Dužina [mm]	Debljina lima [mm]
-----	---------	-----------------	-----------------------	---------------------------------	----------------	-----------------------



FUF OC 62

FUF OC 62	504518	4048962063271	10	10	400	
-----------	--------	---------------	----	----	-----	--

HK 41 - držač profila

Tip	Br.Art.	GTIN (EAN-Code)	Pakovanje [Komada]	Veliko pakovanje [Komada]	Prečnik-Ø [mm]	Debljina lima [mm]
-----	---------	-----------------	-----------------------	---------------------------------	-------------------	-----------------------

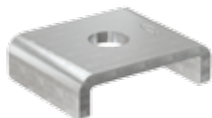

HK

HK 41 12,5	547494	4048962336740	50	50	12,5	
------------	--------	---------------	----	----	------	--

G navojna šipka							
Tip	Br.Art.	GTIN (EAN-Code)	Pakovanje [Komada]	Veliko pakovanje [Komada]		Dužina [mm]	Navoj



G 12/3	064056	4006209640562	5	5		3000	M 12
--------	--------	---------------	---	---	--	------	------

MU - navrtka							
Tip	Br.Art.	GTIN (EAN-Code)	Pakovanje [Komada]	Veliko pakovanje [Komada]		Otvor ključa SW [mm]	



MU M 12	024650	4006209246504	100	100		19	
---------	--------	---------------	-----	-----	--	----	--

U - podloška								
Tip	Br.Art.	GTIN (EAN-Code)	Pakovanje [Komada]	Veliko pakovanje [Komada]		Spoljni prečnik [mm]	Prečnik-Ø [mm]	Debljina [mm]





U 12 x 40	024649	4006209246498	100	100		40	12,5	3
-----------	--------	---------------	-----	-----	--	----	------	---

VM - navrtka produžena								
Tip	Br.Art.	GTIN (EAN-Code)	Pakovanje [Komada]	Veliko pakovanje [Komada]		Navoj	Otvor ključa SW [mm]	Dužina [mm]



VM M 12	020971	4006209209714	100	100		M 12	17	40
---------	--------	---------------	-----	-----	--	------	----	----

SPS, BLR - španer / zatezač							
Tip	Br.Art.	GTIN (EAN-Code)	Pakovanje [Komada]	Veliko pakovanje [Komada]		Navoj [mm]	Dužina [mm]
	SPS						
	BLR						
SPS M 12	064090	4006209640906	25	25		M 12	125
BLR 100 M12	064091	4006209640913	25	25		M 12	100

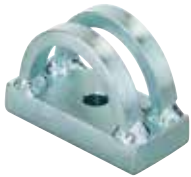
UHRS - nosač univerzalni						
Tip	Br.Art.	GTIN (EAN-Code)	Pakovanje [Komada]	Veliko pakovanje [Komada]		Mogućnost priključka
	UHRS					
UHRS	063938	4006209639382	6	6		M8, M10, M12

FHS Clix S - vijak sa T glavom								
Tip	Br.Art.	GTIN (EAN-Code)	Pakovanje [Komada]	Veliko pakovanje [Komada]		Navoj [mm]	Dužina L1 [mm]	Dužina L2 [mm]
	FHS Clix-S							
FHS CLIX S 12 x 30	020969	4006209209691	50	50		M 12	38	30

FEC - kapa završna							
Tip	Br.Art.	GTIN (EAN-Code)	Pakovanje [Komada]	Veliko pakovanje [Komada]		Za Profil	
	FEC 62 B						
FEC 62 B	505551	4048962070460	100	100		41/62	

FCN Clix P - navrtka klizna							
Tip	Br.Art.	GTIN (EAN-Code)	Pakovanje [Komada]	Veliko pakovanje [Komada]		Navoj	Debljina [mm]



FCN Clix P

FCN Clix P 12	504331	4048962062458	100	100		M 12	9,5
---------------	--------	---------------	-----	-----	--	------	-----

FCN - navrtka klizna							
Tip	Br.Art.	GTIN (EAN-Code)	Pakovanje [Komada]	Veliko pakovanje [Komada]		Navoj	Debljina [mm]



FCN

FCN 12	077411	4006209774113	100	100		M 12	9
--------	--------	---------------	-----	-----	--	------	---

FSFP - čvrsta tačka sa zvučnom izolacijom

Tip	Br.Art.	GTIN (EAN-Code)	Pakovanje [Komada]	Veliko pakovanje [Komada]	Nazivna veličina [Zoll]	Širina x debljina lima [mm]
-----	---------	-----------------	-----------------------	---------------------------------	----------------------------	--------------------------------



FSFP

FSFP 1"	512716	1)	4048962118384	1	1	1"	20 x 1,5
FSFP 1 1/4"	512717	1)	4048962118391	1	1	1 1/4"	20 x 2,0
FSFP 1 1/2"	512718	1)	4048962118407	1	1	1 1/2"	20 x 2,0
FSFP 2"	512719	1)	4048962118414	1	1	2"	30 x 2,5
FSFP 2 1/2"	512720	1)	4048962118421	1	1	2 1/2"	30 x 2,5
FSFP 3"	512721	1)	4048962118438	1	1	3"	30 x 2,5
FSFP 4"	512722	1)	4048962118445	1	1	4"	30 x 2,5

1) Rok isporuke na upit

FFPS - objujmica čvrste tačke

Tip	Br.Art.	GTIN (EAN-Code)	Pakovanje [Komada]	Veliko pakovanje [Komada]	Nazivna veličina [Zoll]	Širina B [mm]	Vijak za zaključavanje
-----	---------	-----------------	-----------------------	---------------------------------	----------------------------	------------------	---------------------------



FFPS

FFPS 2"	048510		4006209485101	1	10	2"	137	M 12
FFPS 2 1/2"	048511		4006209485118	1	10	2 1/2"	156	M 12
FFPS 3"	048512		4006209485125	1	10	3"	170	M 12
FFPS 4"	048513		4006209485132	1	5	4"	191	M 12
FFPS 5"	048660		4006209486603	1	5	5"	217	M 12
FFPS 159 - 166	048662		4006209486627	1	5	159 - 166	243	M 12
FFPS 6"	048663		4006209486634	1	4	6"	250	M 12
FFPS 8"	048664		4006209486641	1	4	8"	303	M 12
FFPS 10"	048665		4006209486658	1	4	10"	351	M 12

FFPK - objujmica čvrste tačke

Tip	Br.Art.	GTIN (EAN-Code)	Pakovanje [Komada]	Veliko pakovanje [Komada]
-----	---------	-----------------	-----------------------	---------------------------------



FFPK

FFPK	048666		4006209486665	1	1
------	--------	--	---------------	---	---

GLL / GL 3/4" - klizni element									
Tip	Br.Art.	GTIN (EAN-Code)	Pakovanje	Veliko pakovanje		Priključni navoj	Max preporučena dužina cevnog nastavka	Max dužina klizanja (W)	Max. preporučeni prečnik cevi
			[Komada]	[Komada]			[mm]	[mm]	
GLL 3/4"	064038	4006209640388	5	5		3/4"	200	165	200
GL 3/4"	064041	4006209640418	5	5		3/4"	200	165	200

SBS - klizni element								
Tip	Br.Art.	GTIN (EAN-Code)	Pakovanje	Veliko pakovanje		Priključni navoj	Max dužina klizanja (W)	Max. preporučeni prečnik cevi
			[Komada]	[Komada]			[mm]	
SBS M 8	079685	4006209796856	8	8		M 8	60	bis DN 80
SBS M 10	079686	4006209796863	8	8		M 10	55	bis DN 80
SBS 12/16	047726	4006209477267	1	1		M 12 / M 16	125	-

FSC 1 - klizni element							
Tip	Br.Art.	GTIN (EAN-Code)	Pakovanje	Veliko pakovanje		Max preporučena dužina cevnog nastavka	Max. preporučeni prečnik cevi
			[Komada]	[Komada]		[mm]	
FSC 1	507866	8001132078662	12	12		140	bis zu DN 100

SB - klizni element								
Tip	Br.Art.	GTIN (EAN-Code)	Pakovanje	Veliko pakovanje		Priključni navoj	Max dužina klizanja (W)	Visina H
			[Komada]	[Komada]			[mm]	[mm]
SB M 8	079680	4006209796801	25	25		M 8	30	75
SB M 10	079681	4006209796818	25	25		M 10	30	90

PDH / PDH K - nosač zglobni									
Tip	Br.Art.	GTIN (EAN-Code)	Pakovanje [Komada]	Veliko pakovanje [Komada]		Dužina [mm]	Navoj (spoljni / unutrašnji)	Regulacija visine [mm]	Izvijanje / otklon [°]



PDH

PDH M 8	079676	4006209796764	50	50		76	M 8	25	12
PDH M 10	079677	4006209796771	50	50		80	M 10	25	12
PDH M 12	064037	4006209640371	25	25		90	M 12	25	12
PDH K M 8	068267	4006209682678	50	50		50	M 8	-	12
PDH K M 10	068269	4006209682692	50	50		54	M 10	-	12

LGS - objumice za ventilaciju

Tip	Br.Art.	GTIN (EAN-Code)	Pakovanje [Komada]	Veliko pakovanje [Komada]		Priključni navoj	Širina x debljina [mm]	Vijak za zakl- jučavanje	Nazivna veličina [mm]
-----	---------	-----------------	-----------------------	---------------------------------	--	------------------	------------------------------	-----------------------------	-----------------------------



LGS

LGS 80	079491	4006209794913	25	25		M 8 / M 10	-	M 6	80
LGS 90	079492	4006209794920	25	25		M 8 / M 10	-	M 6	90
LGS 100	079493	4006209794937	20	20		M 8 / M 10	-	M 6	100
LGS 112	079494	4006209794944	20	20		M 8 / M 10	-	M 6	112
LGS 125	079495	4006209794951	10	10		M 8 / M 10	-	M 6	125
LGS 140	079496	4006209794968	10	10		M 8 / M 10	-	M 6	140
LGS 150	079497	4006209794975	10	10		M 8 / M 10	-	M 6	150
LGS 160	079498	4006209794982	10	10		M 8 / M 10	-	M 6	160
LGS 180	079499	4006209794999	10	10		M 8 / M 10	-	M 6	180
LGS 200	079500	4006209795002	15	15		M 8 / M 10	-	M 6	200
LGS 224	079501	4006209795019	15	15		M 8 / M 10	-	M 6	224
LGS 250	079502	4006209795026	10	10		M 8 / M 10	-	M 6	250
LGS 280	079503	4006209795033	10	10		M 8 / M 10	-	M 6	280
LGS 300	079504	4006209795040	10	10		M 8 / M 10	-	M 6	300
LGS 315	079505	4006209795057	10	10		M 8 / M 10	-	M 6	315
LGS 355	079506	4006209795064	10	10		M 8 / M 10	-	M 6	355
LGS 400	079507	4006209795071	10	10		M 8 / M 10	-	M 6	400
LGS 450	024637 1)	4006209246375	1	1		M 8 / M 10	-	M 10	450
LGS 500	024638 1)	4006209246382	1	1		M 8 / M 10	-	M 10	500
LGS 560	024639 1)	4006209246399	1	1		M 8 / M 10	-	M 10	560
LGS 600	024640 1)	4006209246405	1	1		M 8 / M 10	-	M 10	600
LGS 630	542960 1)	4048962301342	1	1		M 8 / M 10	-	M 10	630
LGS 710	542962 1)	4048962301366	1	1		M 8 / M 10	-	M 10	710
LGS 800	024643 1)	4006209246436	1	1		M 8 / M 10	-	M 10	800
LGS 900	024644 1)	4006209246443	1	10		M 8 / M 10	-	M 10	900
LGS 1000	024645 1)	4006209246450	1	1		M 8 / M 10	-	M 10	1000
LGS 1120	024646 1)	4006209246467	1	1		M 8 / M 10	-	M 10	1120
LGS 1250	024647 1)	4006209246474	1	1		M 8 / M 10	-	M 10	1250

1) Kod montaže sa dve navojne šipke moguće je dupliranje navedenog opterećenja

LKH / ZKH - nosači ventilacionih kanala

Tip	Br.Art.	GTIN (EAN-Code)	Pakovanje [Komada]	Veliko pakovanje [Komada]		Za Navoj	Izvedba
-----	---------	-----------------	-----------------------	---------------------------------	--	----------	---------



LKH



LKHN

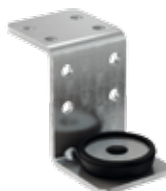





ZKH



ZKHN

LKH	024671	4006209246719	50	50		M 8	umetnuto
LKHN	516537	4048962138702	50	50		M 8 / M 10	Presovano
ZKH	024674	4006209246740	50	50		M 8	umetnuto
ZKHN	516540	4048962138733	50	50		M 8 / M 10	Presovano

LRB - nosači ventilacionih cevi							
Tip	Br.Art.	GTIN (EAN-Code)	Pakovanje [Komada]	Veliko pakovanje [Komada]		Za Navoj	Izvedba
 LRB	024675	4006209246757	50	50		M 8	Presovano
 LRBN	077613	4006209776131	50	50		M 8 / M 10	umetnuto

TZ - nosači za trapezni lim							
Tip	Br.Art.	GTIN (EAN-Code)	Pakovanje [Komada]	Veliko pakovanje [Komada]			
 TZ							
 TZA							
 TZH							
TZ M 8	064094	4006209640944	25	25			
TZ M 10	064095	4006209640951	25	25			
TZA M10	524047	4048962193879	50	50			
TZH M 8	079825	4006209798256	25	25			
TZH M 10	079826	4006209798263	25	25			

LZ - klješta za probijanje trapeznog lima							
Tip	Br.Art.	GTIN (EAN-Code)	Pakovanje [Komada]	Veliko pakovanje [Komada]			
 LZ							
LZ	079830	4006209798300	1	1			

LST - probijači za klješta							
Tip	Br.Art.	GTIN (EAN-Code)	Pakovanje [Komada]	Veliko pakovanje [Komada]			
 LST							
LST10	079829	4006209798294	2	200			

EMS - gumeni umetak za montažne šine							
Tip	Br.Art.	GTIN (EAN-Code)	Pakovanje [Komada]	Veliko pakovanje [Komada]		Za Profil	Dužina [m]
							
EMS							
EMS 31	538752	4048962265972	1	1		Sve FLS šine	-
EMS 41	550806	4048962063608	1	25		Sve FUS šine	6

TKL - stega montažna						
Tip	Br.Art.	GTIN (EAN-Code)	Pakovanje [Komada]	Veliko pakovanje [Komada]		Navoj



TKL

TKL L M 8	064055	4006209640555	50	50		M 8
TKL M 8	079687	4006209796870	50	50		M 8
TKL L Ø 9	077605	4006209776056	50	50		Ø 9
TKL M 10	079688	4006209796887	50	50		M 10
TKL Ø 11	079689	4006209796894	50	50		Ø 11
TKL M 12	020949	4006209209493	50	50		M 12
TKL Ø 13	043275	4006209432754	50	50		Ø 13



SS-TKL

SS-TKL M10/M12	048154	4006209481547	25	25		Ø 10 / Ø 12
----------------	--------	---------------	----	----	--	-------------

TKLS - stega montažna; udarna						
Tip	Br.Art.	GTIN (EAN-Code)	Pakovanje [Komada]	Veliko pakovanje [Komada]		Odgovarajuće za profile debljine [mm]



TKLS

TKLS Ø 9	531134	4048962207576	25	25		8 - 20
TKLS Ø 11	531136	4048962207583	25	25		8 - 20
TKLS Ø 13	531137	4048962207590	25	25		8 - 20
TKLS Ø 17	531138	4048962207606	16	16		11 - 26

G navojna šipka							
Tip	Br.Art.	GTIN (EAN-Code)	Pakovanje [Komada]	Veliko pakovanje [Komada]		Dužina [mm]	Navoj
							
G 6	020956	4006209209561	50	50		1000	M 6
G 8	079740	4006209797402	25	25		1000	M 8
G 10	079744	4006209797440	25	25		1000	M 10
G 8/2	079741	4006209797419	25	25		2000	M 8
G 10/2	079745	4006209797457	25	25		2000	M 10
G 10/3	557092	8001132570920	5	5		3000	M 10
G 12	020957	4006209209578	20	20		1000	M 12
G 12/2	579746	8001132797464	25	25		2000	M 12
G 12/3	064056	4006209640562	5	5		3000	M 12
G 16	020958	4006209209585	10	10		1000	M 16
G 1/2"	064093	4006209640937	10	10		2000	1/2"
G 3/4"	077580	4006209775806	5	5		2000	3/4"
G 20	557295	8001132572955	5	5		1000	M 20
G 24	557270	8001132572702	5	5		1000	M 24

GS - navojni komad							
Tip	Br.Art.	GTIN (EAN-Code)	Pakovanje [Komada]	Veliko pakovanje [Komada]		Dužina [mm]	Navoj



GS

GS 6/25	544589	4048962316056	100	100		25	M 6
GS 6/40	544590	4048962316063	100	100		40	M 6
GS 6/50	544591	4048962316070	100	100		50	M 6
GS 6/70	544592	4048962316087	100	100		70	M 6
GS 6/80	544593	4048962316094	100	100		80	M 6
GS 6/100	544594	4048962316100	100	100		100	M 6
GS 8/25	079750	4006209797501	100	100		25	M 8
GS 8/40	079751	4006209797518	100	100		40	M 8
GS 8/50	079752	4006209797525	100	100		50	M 8
GS 8/60	079753	4006209797532	100	100		60	M 8
GS 8/70	079754	4006209797549	100	100		70	M 8
GS 8/80	079755	4006209797556	100	100		80	M 8
GS 8/100	079757	4006209797570	100	100		100	M 8
GS 8/120	535535	4048962240535	50	50		120	M 8
GS 8/150	079758	4006209797587	50	50		150	M 8
GS 8/180	535536	4048962240542	50	50		180	M 8
GS 8/200	079759	4006209797594	50	50		200	M 8
GS 10/25	079765	4006209797655	100	100		25	M 10
GS 10/40	079766	4006209797662	100	100		40	M 10
GS 10/60	079767	4006209797679	100	100		60	M 10
GS 10/80	079768	4006209797686	100	100		80	M 10
GS 10/100	079769	4006209797693	100	100		100	M 10
GS 10/120	079770	4006209797709	50	50		120	M 10
GS 10/150	079771	4006209797716	50	50		150	M 10
GS 10/200	079772	4006209797723	50	50		200	M 10
GS 12/40	091442	4006209914427	100	100		40	M 12
GS 12/60	091443	4006209914434	100	100		60	M 12
GS 12/80	091444	4006209914441	100	100		80	M 12
GS 12/100	091461	4006209914618	100	100		100	M 12
GS 12/120	091462	4006209914625	50	50		120	M 12
GS 12/150	091463	4006209914632	50	50		150	M 12
GS 12/200	091464	4006209914649	50	50		200	M 12

GPL, GPS, GPR - ploča osnovna									
Tip	Br.Art.	GTIN (EAN-Code)	Pakovanje [Komada]	Veliko pakovanje [Komada]		Navoj [mm]	Dužina [mm]	Širina B [mm]	Debljina [mm]



GPL, GPS



GPR

GPL M 8	079665	4006209796658	25	25		M 8	80	30	3
GPL M 10	079666	4006209796665	25	25		M 10	80	30	3
GPL M 8/M 10	553637		25	25		M 8/M 10	80	30	3
GPL 1/2"	079667	4006209796672	25	25		1/2"	80	30	3
GPS M 10	079671	4006209796719	25	25		M 10	120	40	4
GPS M 12	040398	4006209403983	25	25		M 12	120	40	4
GPS M 16	504408	4048962062809	25	25		M 16	120	40	4
GPS 1/2"	079672	4006209796726	25	25		1/2"	120	40	4
GPS 3/4"	020968	4006209209684	25	25		3/4"	120	40	4
GPR 1/2"	037289	4006209372890	25	25		1/2"	-	-	4

STST - vijak kombinovani, hangar								
Tip	Br.Art.	GTIN (EAN-Code)	Pakovanje [Komada]	Veliko pakovanje [Komada]		Navoj	Otvor ključa [mm]	Dužina [mm]



STST

STST 6 x 60	504400 1)	4048962062786	100	100		M 6	-	60
STST 6 x 80	077714 1)	4006209777145	100	100		M 6	-	80
STST 8 x 50	079780 1)	4006209797808	100	100		M 8	-	50
STST 8 x 60	079781	4006209797815	100	100		M 8	6	60
STST 8 x 80	079782	4006209797822	100	100		M 8	6	80
STST 8 x 100	079783	4006209797839	100	100		M 8	6	100
STST 8 x 120	079784	4006209797846	100	100		M 8	6	120
STST 8 x 140	079785	4006209797853	50	50		M 8	6	140
STST 8 x 180	079786	4006209797860	50	50		M 8	6	180
STST 10 x 60	077689	4006209776896	100	100		M 10	8	60
STST 10 x 80	077707	4006209777077	100	100		M 10	8	80
STST 10 x 100	077708	4006209777084	100	100		M 10	8	100
STST 10 x 120	077709	4006209777091	100	100		M 10	8	120
STST 10 x 140	077711	4006209777114	50	50		M 10	8	140
STST 10 x 180	077712	4006209777121	50	50		M 10	8	180
STST 12 x 100	535541	4048962240597	100	100		M 12	10	100
STST 12 x 160	535542	4048962240603	50	50		M 12	10	160

1) bez prihvata za ključ

AHB nosač za kačenje							
Tip	Br.Art.	GTIN (EAN-Code)	Pakovanje [Komada]	Veliko pakovanje [Komada]		Za Navoj	Visina [mm]



AHB

AHB	079675	4006209796757	25	25		M8, M10, M12	36
-----	--------	---------------	----	----	--	--------------	----

MW - kocka montažna							
Tip	Br.Art.	GTIN (EAN-Code)	Pakovanje [Komada]	Veliko pakovanje [Komada]		Navoj	[mm]



MW

MW M 8	079717	4006209797174	50	50		M 8	
--------	--------	---------------	----	----	--	-----	--

PV - povezičavč paralelni							
Tip	Br.Art.	GTIN (EAN-Code)	Pakovanje [Komada]	Veliko pakovanje [Komada]		Za Navoj	



PV

PV M 6	020947	4006209209479	100	100		M 6	
PV M 8	079678	4006209796788	100	100		M 8	

SPS/ BLR - španer / zatezač							
Tip	Br.Art.	GTIN (EAN-Code)	Pakovanje [Komada]	Veliko pakovanje [Komada]		Navoj [mm]	Dužina [mm]
							
	SPS	BLR					
SPS M 10	537211	4048962253771	25	25		M 10	125
SPS M 12	064090	4006209640906	25	25		M 12	125
BLR 100 M10	537210	4048962253764	25	25		M 10	100
BLR 100 M12	064091	4006209640913	25	25		M 12	100

SKS - vijak sa mašinskim navojem								
Tip	Br.Art.	GTIN (EAN-Code)	Pakovanje [Komada]	Veliko pakovanje [Komada]		Navoj [mm]	Otvor ključa [mm]	Dužina [mm]
								
	SKS							
SKS 6 x 20	079711	4006209797112	100	100		M 6	10	20
SKS 8 x 16	079415	4006209794159	100	100		M 8	13	16
SKS 8 x 30	079713	4006209797136	100	100		M 8	13	30
SKS 8 x 45	079714	4006209797143	100	100		M 8	13	45
SKS 8 x 55	079715	4006209797150	100	100		M 8	13	55
SKS 8 x 100	079827	4006209798270	100	100		M 8	13	100
SKS 10 x 20	079416	4006209794166	100	100		M 10	17	20
SKS 10 x 30	079417	4006209794173	100	100		M 10	17	30
SKS 10 x 55	079721	4006209797211	100	100		M 10	17	55
SKS 10 x 65	535537	4048962240559	50	50		M 10	17	65
SKS 10 x 85	505552	4048962070477	100	100		M 10	17	85
SKS 12 x 25	535538	4048962240566	100	100		M 12	19	25
SKS 12 x 55	077611	4006209776117	100	100		M 12	19	55
SKS 12 x 65	535539	4048962240573	50	50		M 12	19	65
SKS 12 x 85	505553	4048962070484	100	100		M 12	19	85

U - podloška								
Tip	Br.Art.	GTIN (EAN-Code)	Pakovanje [Komada]	Veliko pakovanje [Komada]		Spoljni prečnik [mm]	Prečnik otvora [mm]	Debljina [mm]



U

U 6 x 12	544595	4048962316117	100	100		12	6,4	1,6
U 8 x 17	091477	4006209914779	100	100		17	8,4	1,6
U 8 x 28	079725	4006209797259	100	100		28	8,4	2
U 8 x 40	079729	4006209797297	100	100		40	8,4	3
U 10 x 21	091478	4006209914786	100	100		21	10,5	2
U 10 x 28	079726	4006209797266	100	100		28	10,5	2
U 10 x 40	079730	4006209797303	100	100		40	10,5	3
U 12 x 24	557301	8001132573013	100	100		24	12,5	2,5
U 12 x 40	024649	4006209246498	100	100		40	12,5	3
U 16 x 30	557303	8001132573037	50	50		30	16,5	3
U 16 x 40	535540	4048962240580	50	50		40	17	3

MU - navrtka								
Tip	Br.Art.	GTIN (EAN-Code)	Pakovanje [Komada]	Veliko pakovanje [Komada]		Otvor ključa [mm]		



MU

MU M 6	079733	4006209797334	100	100		10		
MU M 8	046301	4006209463017	100	100		13		
MU M 10	079735	4006209797358	100	100		17		
MU M 12	024650	4006209246504	100	100		19		
MU M 16	557297	8001132572979	50	50		24		
MU M 20	535532	4048962240511	15	15		30		
MU M 24	535534	4048962240528	15	15		36		

VM - navrtka produžena								
Tip	Br.Art.	GTIN (EAN-Code)	Pakovanje [Komada]	Veliko pakovanje [Komada]		Navoj	Otvor ključa [mm]	Dužina [mm]



VM

VM M 6	014319	4006209143193	100	100		M 6	10	25
VM M 8	079690	4006209796900	100	100		M 8	11	30
VM M 10	079691	4006209796917	100	100		M 10	13	30
VM M 12	020971	4006209209714	100	100		M 12	17	40

AG - vijak sa oknom							
Tip	Br.Art.	GTIN (EAN-Code)	Pakovanje [Komada]	Veliko pakovanje [Komada]		Dužina [mm]	Navoj



AG - vijak sa oknom

AG 8 x 25	079696	4006209796962	100	100		25	M 8
AG 10 x 25	079697	4006209796979	100	100		25	M 10

RAH - navrtka sa oknom							
Tip	Br.Art.	GTIN (EAN-Code)	Pakovanje [Komada]	Veliko pakovanje [Komada]		Prečnik otvora [mm]	Unutrašnji navoj



RAH

RAH M 8	079698	4006209796986	50	50		12,0	M 8
RAH M 10	079699	4006209796993	50	50		12,0	M 10

RD - redukcija navojna							
Tip	Br.Art.	GTIN (EAN-Code)	Pakovanje [Komada]	Veliko pakovanje [Komada]		Unutrašnji navoj	Spoljni navoj





RD

RD M 6 / M 8	079694	4006209796948	100	100		M 6	M 8
RD M 8 / M 6	020936	4006209209363	100	100		M 8	M 6
RD M 10 / M 8	079692	4006209796924	50	50		M 10	M 8
RD M 12 / M 10	079693	4006209796931	100	100		M 12	M 10
RD M 12 / M 16	504397	4048962062755	50	50		M 12	M 16
RD M 16 / M 12	504399	4048962062779	50	50		M 16	M 12
RD 1/2" / M10	079695	4006209796955	10	10		1/2"	M 10
RD M 16 / M 12 duga	538080	4048962260908	10	10		M 16	M 12
RD 1/2" / M 10 duga	537215	4048962253818	10	10		1/2"	M 10
RD 3/4" / M 12 duga	537213	4048962253795	10	10		3/4"	M 12
RD 3/4" / M 16 duga	537214	4048962253801	10	10		3/4"	M 16



RDM / GRD - reducir navojni							
Tip	Br.Art.	GTIN (EAN-Code)	Pakovanje [Komada]	Veliko pakovanje [Komada]		Unutrašnji navoj	Spoljni navoj
							
	RDM	GRD					
RDM M 10 / M 8	079413	4006209794135	50	50		M 10	M 8
RDM M 12 / M 10	079414	4006209794142	100	100		M 12	M 10
GRD 1/2" / M 10	077609	4006209776094	100	100		M 10	1/2"
GRD 1/2" / M 12	077608	4006209776087	100	100		M 12	1/2"
GRD 3/4" / M 10	077607	4006209776070	100	100		M 10	3/4"
GRD 3/4" / M 12	077606	4006209776063	100	100		M 12	3/4"

LLS - zavrtanj sa dugim otvorom						
Tip	Br.Art.	GTIN (EAN-Code)	Pakovanje [Komada]	Veliko pakovanje [Komada]		Dužina [mm]
						
	LLS					
LLS 6 x 50	079700	4006209797006	100	100		50
LLS 8 x 50	079701	4006209797013	100	100		50

GWB - traka montažna, tekstilna								
Tip	Br.Art.	GTIN (EAN-Code)	Pakovanje [Komada]	Veliko pakovanje [Komada]		Ukupna dužina [mm]	Debljina [mm]	Širina [mm]
								
	GWB							
GWB	020959	4006209209592	10	10		10000	1,1	15

LBV / LBK - traka perforirana									
Tip	Br.Art.	GTIN (EAN-Code)	Pakovanje [Komada]	Veliko pakovanje [Komada]		Prečnik otvora [mm]	Ukupna dužina [mm]	Širina B [mm]	Debljina [mm]
									
LBV 12	079549	4006209795491	10	10		5	10000	12	0,75
LBV 17	079550	4006209795507	10	10		6,5	10000	17	0,75
LBV 25	079551	4006209795514	8	8		8,5	10000	25	0,88
LBK 14	079553	4006209795538	10	10		5	10000	14	2,6
LBK 19	079554	4006209795545	8	8		6,5	10000	19	2,4
LBK 27	079555	4006209795552	5	5		8,5	10000	27	2,4

ED - ekser								
Tip	Br.Art.	GTIN (EAN-Code)	Pakovanje [Komada]	Veliko pakovanje [Komada]		Dužina [mm]	Prečnik [mm]	Max pričvrtna debljina [mm]
								
ED 15	048212	4006209482124	200	4000		15	4,0	2
ED 18	079815	4006209798157	200	4000		18	4,0	6
ED 22	014570	4006209145708	200	4000		22	4,0	10

SZE - alat za montažu eksera								
Tip	Br.Art.	GTIN (EAN-Code)	Pakovanje [Komada]	Veliko pakovanje [Komada]				
								
SZE	552149	4048962357417	1	10				
								
Rezervni delovi	552150	4048962357424	3	900				

Montažne šine FUS fvz; toplacinkovano

Tip	Br.Art.	GTIN (EAN-Code)	Pakovanje [Komada]	Veliko pakovanje [Komada]	Dužina [mm]	Debljina lima [mm]
-----	---------	-----------------	-----------------------	---------------------------------	----------------	-----------------------



FUS 21/1,5 - 3 m fvz	545128 1)	4048962320657	1	50	3000	1,5
FUS 21/2,0 - 3 m fvz	537653	4048962257182	1	1	3000	2
FUS 41/1,5 - 3 m fvz	545129 1)	4048962320664	1	50	3000	1,5
FUS 41/2,0 - 3 m fvz	517426	4048962145397	1	1	3000	2
FUS 41/2,0 - 6 m fvz	537656	4048962257205	1	1	6000	2
FUS 41/2,5 - 6 m fvz	537658	4048962257229	1	1	6000	2,5
FUS 62/2,5 - 3 m fvz	517427	4048962145403	1	1	3000	2,5
FUS 62/2,5 - 6 m fvz	517428	4048962145410	1	1	6000	2,5



FUS 21D/2,0 - 3 m fvz	537659	4048962257236	1	1	3000	2
FUS 21D/2,0 - 6 m fvz	537661	4048962257250	1	1	6000	2
FUS 41D/2,5 - 6 m fvz	537662	4048962257267	1	5	6000	2,5
FUS 62D/2,5 - 6 m fvz	537663	4048962257274	1	1	6000	2,5

1) upitati za rok isporuke

FUF OC fvz - spojnica šine, toplacinkovano

Tip	Br.Art.	GTIN (EAN-Code)	Pakovanje [Komada]	Veliko pakovanje [Komada]	Dužina [mm]
-----	---------	-----------------	-----------------------	---------------------------------	----------------



FUF OC 41 fvz	517415	4048962145311	20	20	200
FUF OC 62 fvz	537591	4048962256963	10	10	400

FCA fvz - konzole, toplocinkovano

Tip	Br.Art.	GTIN (EAN-Code)	Pakovanje [Komada]	Veliko pakovanje [Komada]	Dužina [mm]	Profil
-----	---------	-----------------	-----------------------	---------------------------------	----------------	--------



FCA 41 fvz



FCA 62 fvz



FCA 41D fvz

FCA 41 - 300 fvz	517411	4048962145274	1	1	300	41/2,5
FCA 41 - 450 fvz	517412	4048962145281	1	1	450	41/2,5
FCA 41 - 600 fvz	517413	4048962145298	1	1	600	41/2,5
FCA 41 - 750 fvz	517414	4048962145304	1	1	750	41/2,5
FCA 62 - 1000 fvz	538015	4048962260373	1	1	1000	62/2,5
FCA 41D - 750 fvz	538016	4048962260380	1	1	750	41D/2,5
FCA 41D - 1000 fvz	538017	4048962260397	1	1	1000	41D/2,5

FCAM fvz - konzole, toplocinkovano

Tip	Br.Art.	GTIN (EAN-Code)	Pakovanje [Komada]	Veliko pakovanje [Komada]	Dužina [mm]	Visina H [mm]
-----	---------	-----------------	-----------------------	---------------------------------	----------------	------------------



FCAM fvz

FCAM 300 fvz	538018	4048962260403	1	1	300	246
FCAM 400 fvz	538019	4048962260410	1	1	400	270
FCAM 500 fvz	538020	4048962260427	1	1	500	284
FCAM 600 fvz	538021	4048962260434	1	1	600	319
FCAM 700 fvz	538022	4048962260441	1	1	700	343

FEC - kapa završna

Tip	Br.Art.	GTIN (EAN-Code)	Pakovanje [Komada]	Veliko pakovanje [Komada]	Za Profil
-----	---------	-----------------	-----------------------	---------------------------------	-----------



FEC 21 B



FEC 41 B



FEC 62 B

FEC 21 B	077357	4006209773574	100	100	41/21
FEC 41 B	077355	4006209773550	100	100	41/41
FEC 62 B	505551	4048962070460	100	100	41/62

FCN Clix P fvz / FCN Clix M fvz - navrtka klizna, toplocinkovano							
Tip	Br.Art.	GTIN (EAN-Code)	Pakovanje [Komada]	Veliko pakovanje [Komada]		Navoj	Debljina [mm]



FCN Clix P fvz



FCN Clix M fvz

FCN Clix P 8 fvz	538106	4048962261073	100	100		M 8	6
FCN Clix P 10 fvz	538107	4048962261080	100	100		M 10	8
FCN Clix P 12 fvz	517420	4048962145328	100	100		M 12	9,5
FCN Clix M 8 fvz	538108	4048962261097	100	100		M 8	6
FCN Clix M 10 fvz	538109	4048962261103	100	100		M 10	8
FCN Clix M 12 fvz	538110	4048962261110	100	100		M 12	9,5

HK 41 fvz - držač profila, toplocinkovano							
Tip	Br.Art.	GTIN (EAN-Code)	Pakovanje [Komada]	Veliko pakovanje [Komada]		Rupa-Ø [mm]	



HK fvz

HK 41 10,5 fvz	547496	4048962336764	50	50		10,5	
HK 41 12,5 fvz	547495	4048962336757	50	50		12,5	

SF fvz - stopa šine, toplocinkovano							
Tip	Br.Art.	GTIN (EAN-Code)	Pakovanje [Komada]	Veliko pakovanje [Komada]			



SF L 41 fvz



SF L 82 fvz



SF L 124 fvz

SF L 41 fvz	517421	4048962145342	10	10			
SF L 82 fvz	538125	4048962261264	5	5			
SF L 124 fvz	538126	4048962261271	5	5			

UWS fvz - ugaonik univerzalni, toplocinkovano

Tip	Br.Art.	GTIN (EAN-Code)	Pakovanje [Komada]	Veliko pakovanje [Komada]		
-----	---------	-----------------	-----------------------	---------------------------------	--	--



UW S fvz

UWS fvz	538115	4048962261165	10	10		
---------	--------	---------------	----	----	--	--

WK fvz - ugaonik univerzalni, toplocinkovano

Tip	Br.Art.	GTIN (EAN-Code)	Pakovanje [Komada]	Veliko pakovanje [Komada]		
-----	---------	-----------------	-----------------------	---------------------------------	--	--



WK 100/100 fvz



WK 200/200 fvz

WK 100/100 fvz	538117	4048962261189	5	5		
WK 200/200 fvz	538118	4048962261196	5	5		

FSB fvz - zatezni element, toplocinkovano

Tip	Br.Art.	GTIN (EAN-Code)	Pakovanje [Komada]	Veliko pakovanje [Komada]		
-----	---------	-----------------	-----------------------	---------------------------------	--	--



FSB fvz

FSB 45° fvz	538120	4048962261219	20	20		
-------------	--------	---------------	----	----	--	--

TKR fvz- nosač šine, toplocinkovano

Tip	Br.Art.	GTIN (EAN-Code)	Pakovanje [Komada]	Veliko pakovanje [Komada]	Navoj [mm]	Za Profil
-----	---------	-----------------	-----------------------	---------------------------------	---------------	-----------



TKR fvz

TKR 21- 42 fvz	538122	4048962261233	20	20	M 10	21, 41
TKR 82 fvz	538123	4048962261240	20	20	M 10	62, 41D
TKR 124 fvz	538124	4048962261257	10	10	M 10	62 D

FFF fvz - ploče za spajanje, toplocinkovano

Tip	Br.Art.	GTIN (EAN-Code)	Pakovanje [Komada]	Veliko pakovanje [Komada]		
-----	---------	-----------------	-----------------------	---------------------------------	--	--



FFF 1 fvz



FFF 3L fvz



FFF 4 fvz

FFF 1 fvz	547506	4048962336863	25	25		
FFF 3L fvz	537581	4048962256864	25	25		
FFF 4 fvz	547507	4048962336870	25	25		

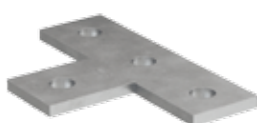

FFF 4T fvz



FFF 4D fvz

FFF 4T fvz	537583	4048962256888	25	25		
FFF 4D fvz	537584	4048962256895	25	25		

FAF fvz - elementi za spajanje, toplocinkovano

Tip	Br.Art.	GTIN (EAN-Code)	Pakovanje [Komada]	Veliko pakovanje [Komada]		
-----	---------	-----------------	-----------------------	---------------------------------	--	--



FAF 4/135° fvz



FAF 2 fvz









FAF 3 fvz



FAF 4 fvz

FAF 4/135° fvz	547511	4048962336917	25	25		
FAF 2 fvz	547508	4048962336887	25	25		
FAF 3 fvz	547509	4048962336894	25	25		
FAF 4 fvz	547510	4048962336900	25	25		

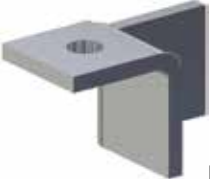
FUF fvz - elementi za spajanje, toplocinkovano

Tip	Br.Art.	GTIN (EAN-Code)	Pakovanje [Komada]	Veliko pakovanje [Komada]		
	FUF 21 fvz					
	FUF 41 fvz					
	FUF 4Y fvz					
FUF 21 fvz	537588	4048962256932	25	25		
FUF 41 fvz	537589	4048962256949	25	25		
FUF 4Y fvz	537585	4048962256901	20	20		
	FUF 180°L fvz					
	FUF 180°R fvz					
	FUF 8T fvz					
FUF 180°L fvz	537586	4048962256918	20	20		
FUF 180°R fvz	537587	4048962256925	20	20		
FUF 8T fvz	537590	4048962256956	10	10		

G fvz, navojna šipka, toplocinkovano

Tip	Br.Art.	GTIN (EAN-Code)	Pakovanje [Komada]	Veliko pakovanje [Komada]	Dužina [mm]	Navoj
	G fvz					
G 8 fvz	537691	4048962257472	25	25	1000	M 8
G 10 fvz	537694	4048962257489	25	25	1000	M 10
G 12 fvz	537695	4048962257496	20	20	1000	M 12
G 16 fvz	537696	4048962257502	10	10	1000	M 16

U fvz - podloška, toplocinkovano

Tip	Br.Art.	GTIN (EAN-Code)	Pakovanje [Komada]	Veliko pakovanje [Komada]	spoljni prečnik [mm]	otvor [mm]	debljina [mm]
	U fvz						
U 8 x 28 fvz	537682	4048962257380	100	100	28	8,4	2
U 10 x 21 fvz	537683	4048962257397	100	100	21	10,5	2
U 10 x 40 fvz	537684	4048962257403	100	100	40	10,5	3
U 12 x 24 fvz	537685	4048962257410	100	100	24	13	2,5
U 12 x 40 fvz	537686	4048962257427	100	100	40	13	3

MU fvz - navrtka, toplocinkovana

Tip	Br.Art.	GTIN (EAN-Code)	Pakovanje [Komada]	Veliko pakovanje [Komada]		otvor ključa [mm]
-----	---------	-----------------	-----------------------	---------------------------------	--	----------------------



MU fvz

MU M8 fvz	537687	4048962257434	100	100		13
MU M10 fvz	537688	4048962257441	100	100		17
MU M12 fvz	537689	4048962257458	100	100		19
MU M16 fvz	537690	4048962257465	50	50		24

SKS fvz vijak sa mašinskim navojem, toplocinkovano

Tip	Br.Art.	GTIN (EAN-Code)	Pakovanje [Komada]	Veliko pakovanje [Komada]	Navoj [mm]	otvor ključa [mm]	Dužina [mm]
-----	---------	-----------------	-----------------------	---------------------------------	---------------	----------------------	----------------



SKS fvz

SKS 10 x 25 fvz	537681	4048962257373	100	100	M 10	17	25
SKS 12 x 25 fvz	537680	4048962257366	100	100	M 12	19	25

PFFF zl, element za brzo spajanje, toplocinkovano

Tip	Br.Art.	GTIN (EAN-Code)	Pakovanje [Komada]	Veliko pakovanje [Komada]	Navoj
-----	---------	-----------------	-----------------------	---------------------------------	-------



PFFF 2L zl



PFFF 4L zl

PFFF 2L zl	542721	4048962299298	20	20	-
PFFF 4L zl	542725	4048962299335	25	25	-

PVB zl, nosač šine, toplocnikovano

Tip	Br.Art.	GTIN (EAN-Code)	Pakovanje [Komada]	Veliko pakovanje [Komada]	Navoj
-----	---------	-----------------	-----------------------	---------------------------------	-------



PVB zl

PVB zl	542722	4048962299304	5	5	-
--------	--------	---------------	---	---	---

PSAE zl kosnik, toplocinkovano

Tip	Br.Art.	GTIN (EAN-Code)	Pakovanje [Komada]	Veliko pakovanje [Komada]	Dužina [mm]
-----	---------	-----------------	-----------------------	---------------------------------	----------------



PSAE zl

PSAE zl 300 kosnik	542726	4048962299342	10	10	300
PSAE zl 500 kosnik	542727	4048962299359	10	10	500

PU zl podloška, toplocinkovano

Tip	Br.Art.	GTIN (EAN-Code)	Pakovanje [Komada]	Veliko pakovanje [Komada]	Dužina [mm]
-----	---------	-----------------	-----------------------	---------------------------------	----------------



PU zl podloška, toplocinkovano

PU zl 10,5 podloška, toplocinkovano	542728	4048962299366	50	50	-
PU zl 12,5 podloška, toplocinkovano	542729	4048962299373	50	50	-

PFUF 41 zl, element za spajanje profila, toplocinkovano

Tip	Br.Art.	GTIN (EAN-Code)	Pakovanje [Komada]	Veliko pakovanje [Komada]	Navoj
-----	---------	-----------------	-----------------------	---------------------------------	-------



PFUF 41 zl

PFUF 41 zl	542714	4048962299236	25	25	-
FDCC zl	557278	4048966239962	100	100	-

PFUF OC zl, element za spajanje profila, toplocinkovano



Tip	Br.Art.	GTIN (EAN-Code)	Pakovanje [Komada]	Veliko pakovanje [Komada]	Navoj
-----	---------	-----------------	-----------------------	---------------------------------	-------



PFUF OC zl

PFUF OC zl	542719	4048962299274	6	6	-
------------	--------	---------------	---	---	---



PFUF D zl, element za ugaono spajanje, toplocinkovano

Tip	Br.Art.	GTIN (EAN-Code)	Pakovanje [Komada]	Veliko pakovanje [Komada]		Navoj
 PFUF 3DL zl						
 PFUF 3DR zl						
 PFUF 4D zl						
PFUF 3DL zl	542730	4048962299380	10	10		-
PFUF 3DR zl	542731	4048962299397	10	10		-
PFUF 4D zl	542732	4048962299403	10	10		-





PFCN zl, vijak za brzo spajanje, toplocinkovano

Tip	Br.Art.	GTIN (EAN-Code)	Pakovanje [Komada]	Veliko pakovanje [Komada]		Navoj
 PFCN 41 zl						
PFCN 41 zl	542733	4048962299410	50	50		M 10





PUWS zl, elementi za brzo spajanje FUS profila, toplocinkovano

Tip	Br.Art.	GTIN (EAN-Code)	Pakovanje [Komada]	Veliko pakovanje [Komada]		Navoj
 PUWS 2 x 2/135° zl						
 PUWS 2 x 2 zl						
 PUWS 4 x 4 zl						
PUWS 2 x 2/135° zl	542708	4048962299175	10	10		-
PUWS 2 x 2 zl	542709	4048962299182	10	10		-
PUWS 4 x 4 zl	542710	4048962299199	8	8		-

PFAF zl, elementi za ugaono spajanje, toplocinkovano

Tip	Br.Art.	GTIN (EAN-Code)	Pakovanje [Komada]	Veliko pakovanje [Komada]	Navoj
 PFAF 2 zl	542711	4048962299205	25	25	-
 PFAF 3 zl	542712	4048962299212	25	25	-
 PFAF 4 zl	542724	4048962299328	25	25	-
 PFAF 4/135°	542713	4048962299229	20	20	-

PSF zl, stope profila, toplocinkovano

Tip	Br.Art.	GTIN (EAN-Code)	Pakovanje [Komada]	Veliko pakovanje [Komada]	Za Profil
 PSFQ 41 zl	542723	4048962299311	10	10	41
 PSF 41 zl	542715	4048962299243	5	5	21D, 41, 62
 PSF 82 zl	542716	4048962299250	5	5	41 D
 PSF 124 zl	542718	4048962299267	10	10	62 D

PWK zl, nosač univerzalni, toplocinkovano

Tip	Br.Art.	GTIN (EAN-Code)	Pakovanje [Komada]	Veliko pakovanje [Komada]	Navoj
 PWK 200/200 zl	542720	4048962299281	15	15	-

FRS A2- Obujmice jednodelne									
Tip	Br.Art.	GTIN (EAN-Code)	Pakovanje [Komada]	Veliko pakovanje [Komada]	Br.Art.	Nazivna veličina [Col]	Odgovarajuće za cevi [mm]	Priključni navoj	Širina x deblji- na lima [mm]



FRS A2

FRS 3/8" A2	064290	4006209642900	100	100		3/8"	15 - 19	M 8	20 x 1,2
FRS 1/2" A2	064536	4006209645369	100	100		1/2"	20 - 24	M 8	20 x 1,2
FRS 3/4" A2	064639	4006209646397	100	100		3/4"	25 - 30	M 8	20 x 1,2
FRS 1" A2	064646	4006209646465	100	100		1"	31 - 38	M 8	20 x 1,2
FRS 1 1/4" A2	064669	4006209646694	50	50		1 1/4"	40 - 46	M 8	20 x 1,2
FRS 1 1/2" A2	064673	4006209646731	50	50		1 1/2"	48 - 54	M 8	20 x 1,2
FRS 54 - 58 A2	064674	4006209646748	50	50		-	54 - 59	M 8	20 x 1,2
FRS 2" A2	064675	4006209646755	50	50		2"	60 - 64	M 8	20 x 1,2
FRS 67 - 71 A2	064688	4006209646885	25	25		-	67 - 71	M 8	20 x 1,2
FRS 2 1/2" A2	064689	4006209646892	25	25		2 1/2"	72 - 78	M 10	25 x 1,5
FRS 81 - 86 A2	064693	4006209646939	25	25		-	81 - 86	M 10	25 x 1,5
FRS 3" A2	064694	4006209646946	25	25		3"	87 - 92	M 10	25 x 1,5
FRS 95 - 103 A2	064695	4006209646953	25	25		-	95 - 103	M 10	25 x 1,5
FRS 4" A2	064697	4006209646977	20	20		4"	102 - 116	M 10	25 x 2,0
FRS 121 - 127 A2	064709	4006209647097	10	10		-	121 - 127	M 10	25 x 2,0
FRS 133 - 141 A2	064713	4006209647134	10	10		5"	133 - 141	M 10	25 x 2,0
FRS 159 - 168 A2	064714	4006209647141	8	8		6"	159 - 169	M 10	25 x 2,0

FRS A4- Obujmice jednodelne									
Tip	Br.Art.	GTIN (EAN-Code)	Pakovanje [Komada]	Veliko pakovanje [Komada]	Br.Art.	Nazivna veličina [Col]	Odgovarajuće za cevi [mm]	Priključni navoj	Širina x deblji- na lima [mm]



obujmice FRS A4

FRS 3/8" A4	064864	4006209648643	100	100		3/8"	15 - 19	M 8	20 x 1,2
FRS 1/2" A4	064865	4006209648650	100	100		1/2"	20 - 24	M 8	20 x 1,2
FRS 3/4" A4	064866	4006209648667	100	100		3/4"	25 - 30	M 8	20 x 1,2
FRS 1" A4	064868	4006209648681	100	100		1"	31 - 38	M 8	20 x 1,2
FRS 1 1/4" A4	064869	4006209648698	50	50		1 1/4"	40 - 46	M 8	20 x 1,2
FRS 1 1/2" A4	064870	4006209648704	50	50		1 1/2"	48 - 54	M 8	20 x 1,2
FRS 54 - 58 A4	064873	4006209648735	50	50		-	54 - 59	M 8	20 x 1,2
FRS 2" A4	064874	4006209648742	50	50		2"	60 - 64	M 8	20 x 1,2
FRS 67 - 71 A4	064875	4006209648759	25	25		-	67 - 71	M 8	25 x 1,2
FRS 2 1/2" A4	064879	4006209648797	25	25		2 1/2"	72 - 78	M 10	25 x 1,5
FRS 81 - 86 A4	064892	4006209648926	25	25		-	81 - 86	M 10	25 x 1,5
FRS 3" A4	064893	4006209648933	25	25		3"	87 - 92	M 10	25 x 1,5
FRS 95 - 103 A4	064894	4006209648940	25	25		-	95 - 103	M 10	25 x 1,5
FRS 4" A4	064898	4006209648988	20	20		4"	102 - 116	M 10	25 x 2,0
FRS 121 - 127 A4	064899	4006209648995	10	10		-	121 - 127	M 10	25 x 2,0
FRS 133 - 141 A4	064901	4006209649015	10	10		5"	133 - 141	M 10	25 x 2,0
FRS 159 - 168 A4	064903	4006209649039	8	8		6"	159 - 168	M 10	25 x 2,0

FRS M8/M10 A2 - Obujmice jednodelne

Tip	Br.Art.	GTIN (EAN-Code)	Pakovanje [Komada]	Veliko pakovanje [Komada]		Nazivna veličina [Col]	Odgovarajuće za cevi [mm]	Priključni navoj	Širina x deblji- na lima [mm]
-----	---------	-----------------	-----------------------	---------------------------------	--	------------------------------	---------------------------------	------------------	-------------------------------------



FRS A2

FRS 3/8" M8/M10 A2	512676	4048962118049	100	100		3/8"	15 - 19	M 8 / M 10	20 x 1,25
FRS 1/2" M8/M10 A2	512677	4048962118056	100	100		1/2"	20 - 23	M 8 / M 10	20 x 1,25
FRS 3/4" M8/M10 A2	512678	4048962118063	100	100		3/4"	25 - 30	M 8 / M 10	20 x 1,25
FRS 1" M8/M10 A2	512679	4048962118070	100	100		1"	31 - 38	M 8 / M 10	20 x 1,25
FRS 1 1/4" M8/M10 A2	512681	4048962118087	50	50		1 1/4"	40 - 45	M 8 / M 10	20 x 1,25
FRS 1 1/2" M8/M10 A2	512682	4048962118094	50	50		1 1/2"	48 - 53	M 8 / M 10	20 x 1,25
FRS 2" M8/M10 A2	512683	4048962118100	50	50		2"	60 - 64	M 8 / M 10	20 x 1,25

FRS M8/M10 A4 - Obujmice jednodelne

Tip	Br.Art.	GTIN (EAN-Code)	Pakovanje [Komada]	Veliko pakovanje [Komada]		Nazivna veličina [Col]	Odgovarajuće za cevi [mm]	Priključni navoj	Širina x deblji- na lima [mm]
-----	---------	-----------------	-----------------------	---------------------------------	--	------------------------------	---------------------------------	------------------	-------------------------------------



FRS A4

FRS 3/8" M8/M10 A4	512684	4048962118117	100	100		3/8"	15 - 19	M 8 / M 10	20 x 1,25
FRS 1/2" M8/M10 A4	512685	4048962118124	100	100		1/2"	20 - 23	M 8 / M 10	20 x 1,25
FRS 3/4" M8/M10 A4	512686	4048962118131	100	100		3/4"	25 - 30	M 8 / M 10	20 x 1,25
FRS 1" M8/M10 A4	512687	4048962118148	100	100		1"	31 - 38	M 8 / M 10	20 x 1,25
FRS 1 1/4" M8/M10 A4	512688	4048962118155	50	50		1 1/4"	40 - 45	M 8 / M 10	20 x 1,25
FRS 1 1/2" M8/M10 A4	512689	4048962118162	50	50		1 1/2"	48 - 53	M 8 / M 10	20 x 1,25
FRS 54 - 59 M8/M10 A4	512690	4048962118179	50	50		-	54 - 59	M 8 / M 10	20 x 1,25
FRS 2" M8/M10 A4	512691	4048962118186	50	50		2"	60 - 64	M 8 / M 10	20 x 1,25
FRS 67 - 71 M8/M10 A4	512692	4048962118193	25	25		-	67 - 71	M 8 / M 10	20 x 1,25
FRS 2 1/2" M8/M10 A4	512693	4048962118209	25	25		2 1/2"	72 - 78	M 8 / M 10	25 x 1,5
FRS 3" M8/M10 A4	512694	4048962118216	25	25		3"	87 - 92	M 8 / M 10	25 x 1,5
FRS 95 - 103 M8/M10 A4	512695	4048962118223	25	25		-	95 - 103	M 8 / M 10	25 x 1,5

Montažne šine FUS A2 / A4

Tip	Br.Art.	GTIN (EAN-Code)	Pakovanje [Komada]	Veliko pakovanje [Komada]	Dužina [mm]	Debljina lima [mm]
-----	---------	-----------------	-----------------------	---------------------------------	----------------	-----------------------



FUS 21 A2



FUS 41 A2

FUS 21/2,0 A2 - 2 m	504466	4048962063059	1	50	2000	2
FUS 21/2,0 A2 - 6 m	542735 1)	4048962299434	1	1	6000	2
FUS 41/2,0 A2 - 2 m	504468	4048962063066	1	50	2000	2
FUS 41/2,0 A2 - 6 m	542736 1)	4048962299441	1	1	6000	2
FUS 41/2,5 A2 - 2 m	504470	4048962063073	1	50	2000	2,5
FUS 41/2,5 A2 - 6 m	542737 1)	4048962299458	1	1	6000	2,5
FUS 21/2,0 A4 - 2 m	504472	4048962063080	1	50	2000	2
FUS 21/2,0 A4 - 6 m	542738 1)	4048962299465	1	1	6000	2
FUS 41/2,0 A4 - 2 m	504474	4048962063097	1	50	2000	2
FUS 41/2,0 A4 - 6 m	542739 1)	4048962299472	1	50	6000	2
FUS 41/2,5 A4 - 2 m	504475	4048962063103	1	50	2000	2,5
FUS 41/2,5 A4 - 6 m	542740 1)	4048962299489	1	1	6000	2,5

1) Lieferzeiten auf Anfrage.

FCA A4 - konzole

Tip	Br.Art.	GTIN (EAN-Code)	Pakovanje [Komada]	Veliko pakovanje [Komada]	Dužina [mm]
-----	---------	-----------------	-----------------------	---------------------------------	----------------



FCA A4

FCA 41 A4 - 300	505487	4048962070019	1	1	300
FCA 41 A4 - 450	505488	4048962070026	1	1	450
FCA 41 A4 - 600	505489	4048962070033	1	1	600

FAF A4 - elementi za ugaono spajanje

Tip	Br.Art.	GTIN (EAN-Code)	Pakovanje [Komada]	Veliko pakovanje [Komada]
-----	---------	-----------------	-----------------------	---------------------------------



FAF 2 A4



FAF 2/135° A4



FAF 4 A4

FAF 2 A4	547512	4048962336924	25	25
FAF 4 A4	547513	4048962336931	25	25
FAF 4/135° A4	547514	4048962336948	25	25

SF L A4 - stopa šine

Tip	Br.Art.	GTIN (EAN-Code)	Pakovanje [Komada]	Veliko pakovanje [Komada]		
-----	---------	-----------------	-----------------------	---------------------------------	--	--



SF L A4

SF L 41 A4	504522	4048962063318	10	10		
------------	--------	---------------	----	----	--	--

TKR A4 - nosač šine

Tip	Br.Art.	GTIN (EAN-Code)	Pakovanje [Komada]	Veliko pakovanje [Komada]		
-----	---------	-----------------	-----------------------	---------------------------------	--	--



TKR A4

TKR 21 - 42 A4	504476	4048962063110	20	20		
----------------	--------	---------------	----	----	--	--

HK 41 A4 - držač profila

Tip	Br.Art.	GTIN (EAN-Code)	Pakovanje [Komada]	Veliko pakovanje [Komada]		
-----	---------	-----------------	-----------------------	---------------------------------	--	--

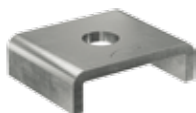

HK 41 A4

HK 41 12,5 - A4	547497	4048962336771	50	50		
-----------------	--------	---------------	----	----	--	--

FCN Clix P A4 / Clix M A4 - navrtka klizna

Tip	Br.Art.	GTIN (EAN-Code)	Pakovanje [Komada]	Veliko pakovanje [Komada]	Debljina [mm]	Navoj
-----	---------	-----------------	-----------------------	---------------------------------	------------------	-------



FCN Clix P A4



FCN Clix M A4

FCN Clix P 8 A4	504436	4048962062908	100	100	6	M 8
FCN Clix P 10 A4	504437	4048962062915	100	100	8	M 10
FCN Clix P 12 A4	504439	4048962062922	100	100	9,5	M 12
FCN Clix M 8 A4	504440	4048962062939	100	100	6	M 8
FCN Clix M 10 A4	504447	4048962062946	100	100	8	M 10

STS A2- vijak kombinovani, hangar							
Tip	Br.Art.	GTIN (EAN-Code)	Pakovanje [Komada]	Veliko pakovanje [Komada]		Navoj	Dužina [mm]



STS A2

STS 8 x 80 A2	065132	4006209651322	100	100		M 8	80
STS 8 x 100 A2	077643	4006209776438	100	100		M 8	100
STS 10 x 100 A2	065153	4006209651537	100	100		M 10	100

G A2 / A4, navojna šipka							
Tip	Br.Art.	GTIN (EAN-Code)	Pakovanje [Komada]	Veliko pakovanje [Komada]		Dužina [mm]	Navoj



G A2/A4

G 8 A2	077644	4006209776445	5	5		1000	M 8
G 10 A2	065173	4006209651735	5	5		1000	M 10
G 8 A4	077645	4006209776452	5	5		1000	M 8
G 10 A4	065174	4006209651742	5	5		1000	M 10

GS A4 navojni komad							
Tip	Br.Art.	GTIN (EAN-Code)	Pakovanje [Komada]	Veliko pakovanje [Komada]		Dužina [mm]	Navoj



GS A4

GS 8/40 A4	505536	4048962070316	100	100		40	M 8
GS 8/60 A4	505537	4048962070323	100	100		60	M 8
GS 10/40 A4	505538	4048962070330	100	100		40	M 10
GS 10/60 A4	505539	4048962070347	100	100		60	M 10

VM A4 - navrtka produžena							
Tip	Br.Art.	GTIN (EAN-Code)	Pakovanje [Komada]	Veliko pakovanje [Komada]		Otvor ključa [mm]	Dužina [mm]



VM A4

VM M8 A4	505540	4048962070354	100	100		11	30
VM M10 A4	505541	4048962070361	100	100		13	30

U A4 - podloška

Tip	Br.Art.	GTIN (EAN-Code)	Pakovanje [Komada]	Veliko pakovanje [Komada]	Spoljni prečnik [mm]	Prečnik otvora [mm]	Debljina [mm]
-----	---------	-----------------	-----------------------	---------------------------------	----------------------------	---------------------------	------------------



U A4

U 8 x 28 A4	505542	4048962070378	100	100	28	8,4	2
U 8 x 40 A4	505543	4048962070385	100	100	40	8,4	3
U 10 x 28 A4	505544	4048962070392	100	100	30	10,5	2
U 10 x 40 A4	505545	4048962070408	100	100	40	10,5	3
U 12 x 24 A4	505546	4048962070415	100	100	24	12,5	2

MU A4 - navrtka

Tip	Br.Art.	GTIN (EAN-Code)	Pakovanje [Komada]	Veliko pakovanje [Komada]	Otvor ključa [mm]	Navoj
-----	---------	-----------------	-----------------------	---------------------------------	----------------------	-------



MU A4

MU M 8 A4	077642	4006209776421	100	100	13	M 8
MU M 10 A4	077641	4006209776414	100	100	17	M 10

SKS A4 - vijak sa mašinskim navojem

Tip	Br.Art.	GTIN (EAN-Code)	Pakovanje [Komada]	Veliko pakovanje [Komada]	Otvor ključa [mm]	Navoj
-----	---------	-----------------	-----------------------	---------------------------------	----------------------	-------



SKS A4

SKS M 10 x 30 A4	505547	4048962070422	100	100	17	M 10
SKS M 12 x 30 A4	505548	4048962070439	100	100	19	M 12

Pričvršćivanje klima uređaja

Kompletan set za pričvršćivanje klima uređaja, pumpi ili ventilatora na zidove



Opis

- Univerzalno pričvršćivanje klima uređaja na zidove.
- Kod svih pričvršćivanja uzima se u obzir nosivost zidova kao i kvalitet zidnih podloga.
- Efikasna i sigurna montaža.
- Za sigurno pričvršćivanje klima uređaja pumpi i ventilatora na zidove sa ili bez elemenata za zaštitu od buke.

Materijal izrade

- **KLIMA EASY**
- **Materijal:** čelik
- **Oblaganje /premaz:** plastifikacija prahom
- **Boja:** RAL 9002
- **KSU**
- **Materijal:** Čelik DX51D+Z 275 MA-C (Materijal-Br. 1.0226+Z) prema DIN EN 10327
- **Cinkovanje:** galvansko cinkovanje ca. 15 µm



Funkcionisanje

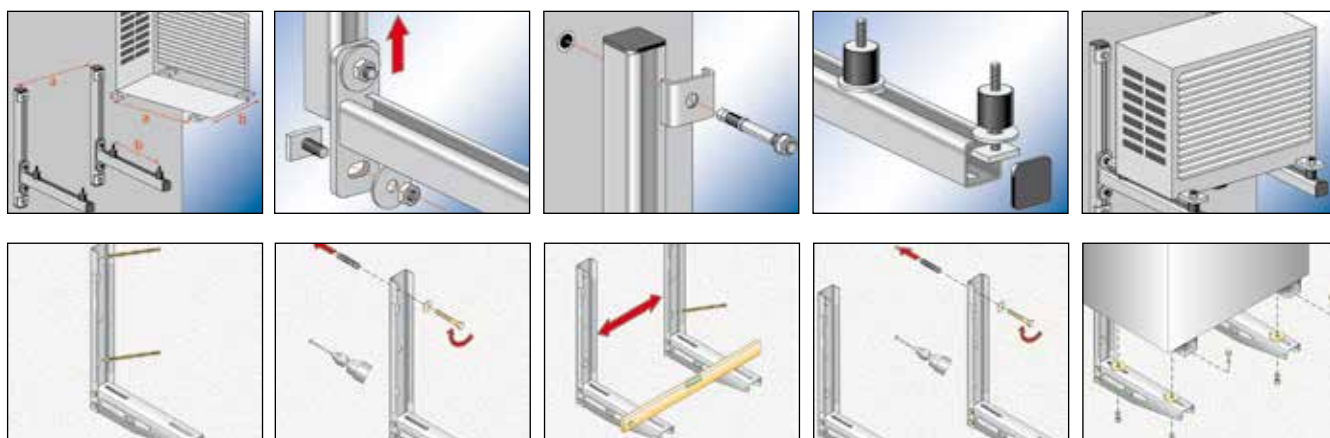

Sanitarna montažna
tehnik - SaMontec

Montaža



MCE LP / PT / TT - pričvrščivanje klima uređaja									
Tip	Br.Art.	GTIN (EAN-Code)	Pakovanje [Komada]	Veliko pakovanje [Komada]		Dužina L1 [mm]	Dužina [mm]	Dužina L3 [mm]	Dužina L4 [mm]
	KLIMA EASY KLIK - RAL 9002								
KLIMA EASY KLIK	521760 1)	8001132030967	1	2		400	420	380	-
	KLIMA KLIK 420 - RAL 9002								
KLIMA KLIK 420	521761 1)	8001132030974	1	2		400	420	380	780

1) specifikacije opterećenja važe za pričvrščivanje sa dva nosača

KSUS - set konzola sa ulošcima za zaštitu od buke									
Tip	Br.Art.	GTIN (EAN-Code)	Pakovanje [Komada]	Veliko pakovanje [Komada]					
	KSU S								
KSU S 450	553736 1)	4048962377910	1	1					
KSU S 500	553737 1)	4048962377927	1	1					
KSU S 600	553738 1)	4048962377934	1	1					

1) specifikacije opterećenja važe za pričvrščivanje sa dva nosača

KSU - set konzola									
Tip	Br.Art.	GTIN (EAN-Code)	Pakovanje [Komada]	Veliko pakovanje [Komada]					
	KSU								
KSU 440	553733 1)	4048962377880	1	1					
KSU 520	553734 1)	4048962377897	1	1					
KSU 600	553735 1)	4048962377903	1	1					





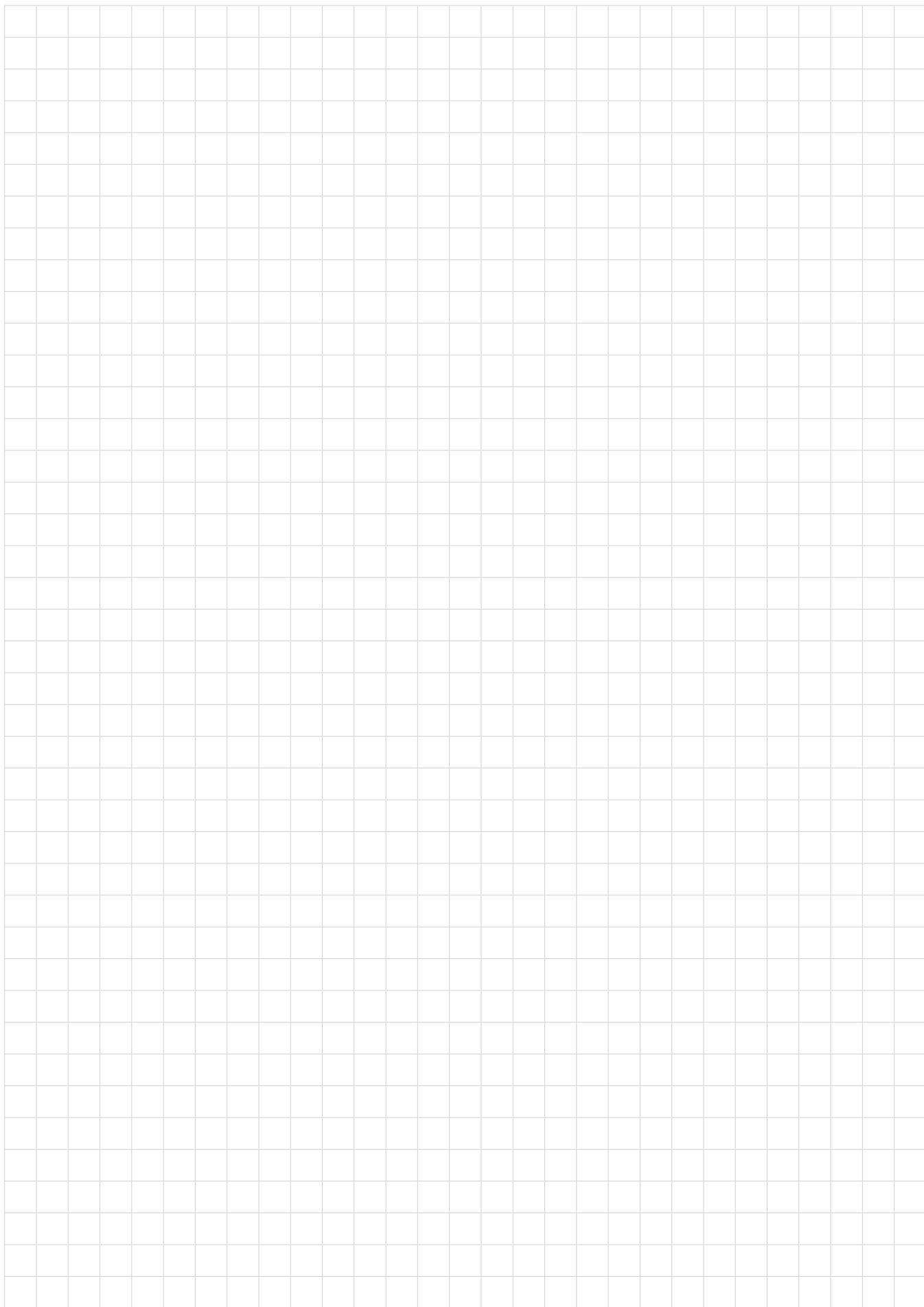



1) specifikacije opterećenja važe za pričvrščivanje sa dva nosača

PA - gumeni ulošci za zaštitu od buke i vibracija						
Tip	Br.Art.	GTIN (EAN-Code)	Pakovanje [Komada]	Veliko pakovanje [Komada]		Sadržaj
						
PA 30 x 30	512715	4048962118377	4	52		4 Komada



Pričvrščivanje sanitarija



			Strana
Pričvrščivanje umivaonika i pisoara	WD		282
Pričvrščivanje bojlera	BO		282
Pričvrščivanje umivaonika	WST		282
Pričvrščivanje pisoara	UST		283
Pričvrščivanje umivaonika i pisoara	WDP		283
Tipli preklopni	KM 10		283
WC- i sanitarna pričvrščivanja	WCN WCR		283
WC- i sanitarna pričvrščivanja	WL		284
Pribor za WC- i sanitarna pričvrščivanja			284

Pričvrščivanje umivaonika i pisoara WD

Tip	Br.Art.	GTIN (EAN-Code)	Pakovanje [Komada]	Veliko pakovanje [Komada]	Sadržaj plastične vrećice [Komada]
-----	---------	-----------------	-----------------------	---------------------------------	---------------------------------------



WD - Pričvrščivanje umivaonika i pisoara

WD 8 x 90	080659	4006209806593	50	50	2 tipla UX 10 x 60, 2 kombinovana vijka M8x90 galvanski pocinkovana, 2 vezivne matice BU M8
WD 8 x 110	080658	4006209806586	50	50	2 tipla UX 10 x 60, 2 kombinovana vijka M8x110 galvanski pocinkovana, 2 vezivne matice BU M8
WD 10 x 120	080655	4006209806555	50	50	2 tipla UX14 x 75, 2 kombinovana vijka M10x120 galvanski pocinkovana, 2 vezivne matice BU M10 MH
WD 10 x 140	080656	4006209806562	50	50	2 tipla UX14 x 75, 2 kombinovana vijka M10x140 galvanski pocinkovana, 2 vezivne matice BU M10 MH

Pričvrščivanje bojlera B0

Tip	Br.Art.	GTIN (EAN-Code)	Pakovanje [Komada]	Veliko pakovanje [Komada]	Sadržaj plastične vrećice [Komada]
-----	---------	-----------------	-----------------------	---------------------------------	---------------------------------------



Pričvrščivanje bojlera B0

B0 120	080654	4006209806548	25	25	4 tipla UX14 x 75, 4 kombinovana vijka M10x120 galvanski pocinkovana, 4 vezivne matice BU M 10
--------	--------	---------------	----	----	--

Pričvrščivanje umivaonika WST

Tip	Br.Art.	GTIN (EAN-Code)	Pakovanje [Komada]	Veliko pakovanje [Komada]	Sadržaj plastične vrećice [Komada]
-----	---------	-----------------	-----------------------	---------------------------------	---------------------------------------



Pričvrščivanje umivaonika WST

WST 10 x 140	080660	4006209806609	50	50	2 tipla UX 14 x 75, 2 kombinovana vijka M10x140 galvanski pocinkovana, 2 vezivne čaure BDH M 10, 2 matice M10 galvanski pocinkovane
WST 12 x 150	080661	4006209806616	50	50	2 tipla UX 14 x 75, 2 kombinovana vijka M12x150 galvanski pocinkovana, 2 vezivne čaure BDH M 12, 2 matice M12 galvanski pocinkovane
WST 12 x 180	080662	4006209806623	50	50	2 tipla UX 14 x 75, 2 kombinovana vijka M12x180 galvanski pocinkovana, 2 vezivne čaure BDH M 12, 2 matice M12 galvanski pocinkovane

Pričvrščivanje pisoara UST

Tip	Br.Art.	GTIN (EAN-Code)	Pakovanje [Komada]	Veliko pakovanje [Komada]	Sadržaj plastične vrećice [Komada]
-----	---------	-----------------	-----------------------	---------------------------------	---------------------------------------



UST 8 x 110 - Pričvrščivanje pisoara

UST 8 x 110	083578	4006209835784	50	50	2 tipla UX10x60, 2 kombinovana vijka M8x110, 2 podloške B 8, 4 DIN 125, 2 plastične podloške 8,4 x 16 x 1,6, 2 matice zatvorene FA 8, 2 kape za pokrivanje hromirane
-------------	--------	---------------	----	----	--



UST 10 x 120 - Pričvrščivanje pisoara

UST 10 x 120	080668	4006209806685	10	10	2 tipla UX14x75, 2 kombinovana vijka M10x120, 2 vezivne matice BU M 10 MH, 2 kape za pokrivanje AKM 10 hrom
--------------	--------	---------------	----	----	---

Pričvrščivanje umivaonika i pisoara WDP							
Tip	Br.Art.	GTIN (EAN-Code)	Pakovanje [Komada]	Veliko pakovanje [Komada]		Navoj [mm]	Dužina tiplje [mm]



Pričvrščivanje umivaonika i pisoara WDP

WDP 10 x 170	014320	4006209143209	10	10		-	170
--------------	--------	---------------	----	----	--	---	-----

Tipi preklopni KM 10										
Tip	Br.Art.	GTIN (EAN-Code)	Pakovanje [Komada]	Veliko pakovanje [Komada]		Prečnik bušenja [mm]	Dužina tiplje [mm]	Min. prostor za tiplje [mm]	Max debljina ploče [mm]	Vijak [mm]

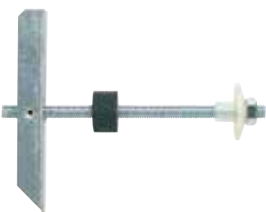

Tipi preklopni KM 10

KM 10	050326	4006209503263	25	25		30	180	140	90	M 10 x 180
-------	--------	---------------	----	----	--	----	-----	-----	----	------------

WC- i sanitarna pričvrščivanja WCN							
Tip	Br.Art.	GTIN (EAN-Code)	Pakovanje [Komada]	Veliko pakovanje [Komada]		Sadržaj plastične vrećice [Komada]	



WCN

WCN 1	060561	4006209605615	50	50		2 tipla S8, 2 zavrtnja za drvo od nerdjajućeg čelika 6 x 70 sa 6ugaonom glavom, 2 pokrivne kape bele boje, 2 plastične odstoje podloške	
WCN 2	060562	4006209605622	50	50		2 tipla S 8, 2 zavrtnja za drvo od nerdjajućeg čelika 6 x 70 sa 6ugaonom glavom, 2 kape za pokrivanje boje hroma, 2 plastične odstoje podloške	

WC- i sanitarna pričvrščivanja WCR							
Tip	Br.Art.	GTIN (EAN-Code)	Pakovanje [Komada]	Veliko pakovanje [Komada]		Sadržaj plastične vrećice [Komada]	



S 8 D 70 WCR

S 8 D 70 WCR	060564	4006209605646	50	50		2 tipla S 8, 2 vijak za drvo od nerdjajućeg čelika 6 x 70 6kt., 2 kape za pokrivanje boje hroma i bele boje, 2 plastične odstoje podloške	
--------------	--------	---------------	----	----	--	---	--



S 8 RD WCR

S 8 RD 60 WCR	060570	4006209605707	50	50		2 tipla S 8 RD 60, 2 vijka od nerdjajućeg čelika 6 x 65 6kt., 2 kape za pokrivanje boje hroma i bele boje	
S 8 RD 80 WCR	060568	4006209605684	50	50		2 tipla S 8 RD 80, 2 vijka od nerdjajućeg čelika 6 x 85 6kt., 2 kape za pokrivanje boje hroma i bele boje	

WC- i sanitarna pričvrščivanja WL						
Tip	Br.Art.	GTIN (EAN-Code)	Pakovanje [Komada]	Veliko pakovanje [Komada]		Sadržaj plastične vrećice [Komada]
						
WC- i sanitarna pričvrščivanja WL WL						
WL 7 x 60	080651	4006209806517	100	100		2 tipla S10, 2 zavrtnja za drvo 7 x 65 sa 6ugaonom glavom galvanski pocinkovani, 2 podloške galvanski pocinkovane
WL 8 x 70	080652	4006209806524	100	100		2 tipla S 10, 2 zavrtnja za drvo 8 x 70 sa 6ugaonom glavom DIN 571 galvanski pocinkovani, 2 podloške galvanski pocinkovane
WL 10 x 80	080650	4006209806500	50	50		2 tipla S 12, 2 zavrtnja za drvo 10 x 80 sa 6ugaonom glavom DIN 571 galvanski pocinkovani, 2 podloške galvanski pocinkovane

WC- pričvrščivanje WB						
Tip	Br.Art.	GTIN (EAN-Code)	Pakovanje [Komada]	Veliko pakovanje [Komada]		Sadržaj
						
WC- pričvrščivanje WB 5N						
WB 5N	018652	4006209186527	50	50		2 tipla SX 10, 2 zavrtnja 7 x 65 galvanski pocinkovana, 2 najlonska ugla, 2 zavrtnja sa krst prihvatom 5 x 45 A2 – nerđajući čelik, 2 odstojne čaure, 2 kape za pokrivanje hromirane

BUM Vezne matice									
Tip	Br.Art.	GTIN (EAN-Code)	Pakovanje [Komada]	Veliko pakovanje [Komada]		Navoj [mm]	Otvor ključa [mm]	Podloška [mm]	Odgovarajuće za
									
BUM Vezne matice									
BU M8 MH	060200 1)	4006209602003	25	250		-	17	40	STS M8
BU M10 MH	060201	4006209602010	25	250		-	17	40	STS M10
BU M12 MH	060204	4006209602041	25	250		-	19	40	STS M12

1) Rok isporuke na upit

Pokrivne kape AKM							
Tip	Br.Art.	GTIN (EAN-Code)	Pakovanje [Komada]	Veliko pakovanje [Komada]		Boja	Odgovarajuće za
							
Pokrivne kape AKM							
AKM 10 W	080972	4006209809723	20	20		Bijela	BU M10 MH
AKM 10 CR	080951	4006209809518	100	100		krom	BU M10 MH
AKM 12 CR	080952	4006209809525	100	100		krom	BU M12 MH



Nagrade



Vaš trgovac

558289 · 04/2021 · Štampano u Austriji.

Zadržavamo pravo izmena zbog grešaka u izradi, tehničkih grešaka ili promene asortimana.
Isključujemo odgovornost za štamparske greške i nedostatke.

Asortiman 2021 / 2022 Serbian



fischer je tu za vas

FISCHER FIXING SYSTEMS
FISCHER AUTOMOTIVE
FISCHERTECHNIK
FISCHER CONSULTING
LNT AUTOMATION

fischer Austria Ges.m.b.H.
Wiener Straße 95
2514 Traiskirchen
www.fischer.at · technik@fischer.at

Tel. +43 (0) 2252 / 53730
DIY - 20
Eksport - 30
Tehnika - 40
Administracija - 50
Fax +43 (0) 2252 / 53730
Velikoprodaja/Tehnika - 70
DIY / Administracija - 71

Firmenbuchnummer FN 112017G
ARA-Lizenz-Nr. 3491
Landesgericht Wr. Neustadt
DVR-Nummer 0095311
UID-Nr. ATU 39615403